



**HAL**  
open science

# Coupling simulation and machine learning for predictive analytics in supply chain management

Tianyuan Zhang, Matthieu Laurus, Gregory Zacharewicz, Souad Rabah,  
Frederick Benaben

► **To cite this version:**

Tianyuan Zhang, Matthieu Laurus, Gregory Zacharewicz, Souad Rabah, Frederick Benaben. Coupling simulation and machine learning for predictive analytics in supply chain management. *International Journal of Production Research*, 2024, 62 (23), pp.8397-8414. 10.1080/00207543.2024.2342019 . hal-04562707

**HAL Id: hal-04562707**

<https://imt-mines-albi.hal.science/hal-04562707v1>

Submitted on 30 Apr 2024

**HAL** is a multi-disciplinary open access archive for the deposit and dissemination of scientific research documents, whether they are published or not. The documents may come from teaching and research institutions in France or abroad, or from public or private research centers.

L'archive ouverte pluridisciplinaire **HAL**, est destinée au dépôt et à la diffusion de documents scientifiques de niveau recherche, publiés ou non, émanant des établissements d'enseignement et de recherche français ou étrangers, des laboratoires publics ou privés.

# Coupling simulation and machine learning for predictive analytics in supply chain management

Tianyuan Zhang <sup>a,b</sup>, Matthieu Luras <sup>a</sup>, Gregory Zacharewicz <sup>c</sup>, Souad Rabah <sup>c</sup> and Frederick Benaben <sup>a</sup>

<sup>a</sup>Industrial Engineering Center, IMT Mines Albi, Albi, France; <sup>b</sup>Center of Excellence in Supply Chain, KEDGE Business School, Talence, France; <sup>c</sup>Laboratory for the Science of Risks, IMT Mines Alès, Alès, France

## ABSTRACT

Predictive analytics is the approach to business analytics that answers the question of what might happen in the future. Although predictive information is critical for making forward-looking decisions, traditional approaches struggle to cope with the increasing uncertainty and complexity that characterise modern supply chains. Simulation is limited by insufficient timeliness, while machine learning is constrained by poor interpretability and data scarcity. Inspired by the complementary nature of simulation and machine learning, an integrated predictive analytics approach is proposed and applied to a humanitarian supply chain. By coupling simulation and machine learning, predictive models can be developed with limited historical data, and pre-crisis performance assessment can be performed to facilitate timely and informed decisions. The proposed approach enables managers to gain valuable insights into the complex evolution of the uncertain future, which also opens up the possibility of further integration with optimisation and digital twins.

## 1. Introduction

Predictive analytics, a branch of business analytics, uses historical data and current conditions to forecast future events (Kamble and Gunasekaran 2020). In supply chain management (SCM), predictive analytics can provide insight into future possibilities and uncertainties, thereby facilitating decision-making with a prospective outlook (Schoenherr and Speier-Pero 2015; Waller and Fawcett 2013). A well-known example is FedEx's use of package movement history for predictive analytics to ensure on-time delivery of COVID-19 vaccines (Zaytsev 2023). From a technical perspective, predictive analytics traditionally involves building simulation models grounded in business understanding and historical data (J. A. Miller, Cotterell, and Buckley 2013). These models enable anticipation through what-if scenario analysis (Dev et al. 2019; Power and Heavin 2017). With advances in data science and artificial intelligence, machine learning now plays a key role in the field (Dwivedi et al. 2021; Gunasekaran et al. 2017; Ranjan and Foropon 2021). By exploring historical data, machine learning algorithms can autonomously discover latent patterns and construct predictive models. From a theoretical perspective, mature theories such as operations research and decision

theory under uncertainty also help to integrate predictive analytics into today's supply chain practices (Lee and Mangalaraj 2022).

Despite its widespread use in SCM, predictive analytics struggles to adapt to today's volatile, uncertain, complex, and ambiguous (VUCA) world (Gao, Feng, and Zhang 2021; Grzybowska and Tubis 2022; Troise et al. 2022). Challenges are both exogenous and endogenous. Exogenous challenges stem from external factors such as geopolitical tensions, natural disasters, and market fluctuations. These factors escalate the uncertainty of the external environment in which supply chains operate, making predictive analytics less reliable (Charles, Luras, and Van Wassenhove 2010). The failure to forecast supply chain disruptions during COVID-19 is a good example of such impacts. Conversely, endogenous challenges arise as supply chains transform to remain competitive. Adaptations such as the pursuit of carbon neutrality increase the internal complexity of supply chains (Pessot, Zangiaccomi, and Fornasiero 2024). There are more variables (such as carbon emissions and supplier sustainability ratings) to consider and more indicators (such as energy efficiency and carbon footprint) to predict, complicating the implementation of predictive analytics.

The above challenges manifest themselves differently for different predictive analytics approaches. For simulation, there are more potential scenarios to simulate due to the rise in uncertainty (Dev et al. 2019; J. A. Miller, Cotterell, and Buckley 2013). Simulation models are more complex and time-consuming given the increasing complexity of supply chains. As a result, simulation-based approaches suffer from reduced timeliness. For machine learning, data scarcity and poor interpretability are the main constraints (Dwivedi et al. 2021). Increased uncertainty hampers the collection of representative data, thereby hindering machine learning model development. Interpretability, defined as the degree to which humans can understand the rationale behind a prediction (T. Miller 2019), ranges from the holistic interpretability of predictive models to the local interpretability of a single prediction (Molnar 2023). Machine learning is often criticised for this aspect. As complexity grows, it's harder to understand why a supply chain would behave as predicted by machine learning.

The above analysis shows that there is a clear research gap between current predictive analytics approaches and the needs of supply chains in the VUCA world. Since different methods face different dilemmas, combining them may provide a viable solution. Inspired by the complementarity of simulation and machine learning, we believe that coupling the two techniques in an integrated predictive analytics approach could address this research gap. The research question (RQ) thus formulated is: How can simulation and machine learning be combined in predictive analytics to help supply chains better manage the increasing uncertainty and complexity? Answering this RQ will not only lead to a novel approach, but also enable modern supply chains to better navigate the VUCA world.

To this end, a comprehensive literature review is presented in Section 2, summarising current advances in combining simulation and machine learning for business analytics. An innovative integrated approach to predictive analytics in supply chains is then proposed in Section 3, which couples simulation and machine learning to enhance timeliness and interpretability while alleviating data scarcity. A case study applying this approach to a humanitarian supply chain is presented in Section 4 for illustrative purposes. The paper ends in Section 5, where conclusions are drawn and future perspectives are contemplated.

## 2. Literature review

This section begins with an overview of combining simulation and machine learning for general business analytics purposes. A detailed review of the literature on

the integration of simulation and machine learning for predictive analytics in SCM is then presented.

### 2.1. Coupling simulation and machine learning for business analytics

Simulation and machine learning have been widely used for analytical purposes in SCM (Rabia and Bellabdaoui 2022; Tirkolaei et al. 2021). Their combination is now attracting interest in both academic and business circles (Baryannis et al. 2019; Hürkamp et al. 2020; von Rueden et al. 2020). Figure 1 categorises this integration into three different types, based on the specific analytical purpose it serves (Souza 2014). Correspondingly, the machine learning algorithms typically employed within each category also differ (Feki, Boughzala, and Wamba 2016).

Descriptive analytics extracts insights from historical data to help managers understand what has happened or is happening in supply chains (Hahn and Packowski 2015). It mainly involves unsupervised learning techniques such as clustering, anomaly detection, and association rule mining to transform supply chain data into valuable information (Blackhurst et al. 2018; Le et al. 2013; Nguyen et al. 2021; Tirkolaei et al. 2021). To augment the analysis of expansive data sets, simulations are often used to examine a multitude of potential scenarios, thereby complementing empirical data from the real world (Rabia and Bellabdaoui 2022). The combination of simulation and machine learning here can be summarised as using simulated data to enrich the input to unsupervised learning models (von Rueden et al. 2020). This allows decision makers not only to be aware of past events, but also to comprehend them from a more holistic perspective.

Predictive analytics concerns what might happen in the future (Hahn and Packowski 2015). For predictive tasks like demand forecasting, supervised learning techniques are applied to train models using historical data (Brahami et al. 2022; Huber and Stuckenschmidt 2020; Kantasa-Ard et al. 2021; Tirkolaei et al. 2021). These models can then make predictions on new inputs. Such data-driven approaches are highly dependent on the quality and quantity of data. When data availability is limited, simulation can be employed to explore potential scenarios and anticipate the future (Huang 2009; Suryani, Chou, and Chen 2012). However, constructing simulation models requires a deep understanding of the business. Because both simulation and machine learning can perform predictive analytics independently, combining the two can be complex. The exchange of data and information between the two can be bidirectional and serve different purposes (von Rueden et al. 2020). The

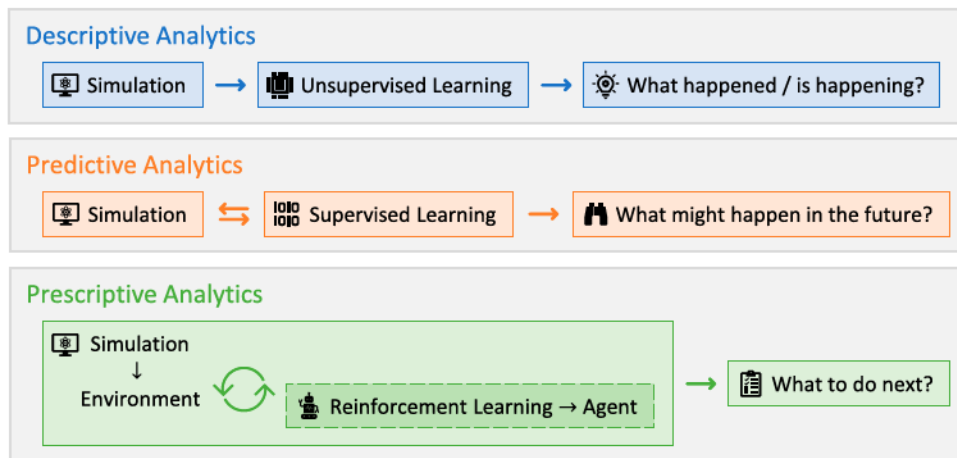

**Figure 1.** Coupling of simulation and machine learning for different analysis purposes.

literature on this topic is examined further in the next subsection.

Prescriptive analytics devotes to answer what to do next by determining the optimal future actions (Feki, Boughzala, and Wamba 2016; Souza 2014). This frequently employs simulation alongside optimisation to formulate problems and identify solutions (Rabia and Bellabdaoui 2022). Reinforcement learning techniques have recently come to the forefront in this field (Rolf et al. 2022). Intelligent agents are created with the ability to take cumulative actions to achieve pre-defined goals (Valluri, North, and Macal 2009). Simulations are typically used to provide the environment in which the agents operate (Kaelbling, Littman, and Moore 1996; Li 2017). Such methods have been explored for various supply chain processes such as scheduling, routing, and resource allocation (Abideen et al. 2021; Lang et al. 2021; Puskás, Budai, and Bohács 2020; Rolf et al. 2022). These studies benefit from well-established simulation methods and quantifiable objectives. Implementing such methods remains challenging when simulation models are difficult to build or desired futures are difficult to characterise.

In summary, the combination of simulation and machine learning varies for different analytical purposes (von Rueden et al. 2020). In descriptive analytics, the coupling of these two approaches is straightforward and well-practised. For prescriptive analytics, their combination is intuitive and has received considerable attention. However, the integration of simulation and machine learning in predictive analytics is more complicated and less investigated.

## 2.2. Coupling simulation and machine learning for predictive analytics

To gain a better understanding of both the advances and limitations of existing research, an in-depth survey was conducted with a specific focus on the integration of simulation and machine learning for predictive analytics in SCM. Attempts to combine the two techniques to innovate the approach to predictive analytics can be observed in certain areas where predictive capability is critical to the success of specific supply chain activities.

One factor driving this trend is the scarcity of historical data, which is insufficient for machine learning to develop predictive models and assess the reliability of predictions. Some studies have attempted to address this issue by incorporating simulations as an alternative data source. One example is the scheduling approach introduced by Heger et al. (2016), which uses Gaussian process regression to predict the performance of dispatching rules, allowing for dynamic adjustments in flow shops. In this study, simulation is employed to generate learning data and to evaluate the learning quality. Similarly, Cavalcante et al. (2019) proposed a supplier selection method in the context of digital manufacturing. Supervised learning algorithms are fed with supplier performance data generated by simulation. Badakhshan and Ball (2022) and Wang (2022) also used simulation to synthesise data for machine learning to predict the occurrence of disruptions for risk management purposes. The above research has mitigated to some extent the negative impact of data scarcity on predictive analytics.

Another factor facilitating the integration of simulation and machine learning is the need for predictive information with different granularities. Machine learning excels in estimating quantifiable metrics at a local scale with high accuracy. Conversely, simulation is adept at characterising complex interactions within supply chains, enabling comprehensive anticipation. Combining the two is conducive to integrating predictive information at different granularities to support decision-making. Many studies are devoted to this direction. Pereira et al. (2018) presented a machine learning-based demand forecasting approach for omnichannel retailing and integrated it with simulation-based optimisation to adaptively synchronise supply and demand (Pereira and Frazzon 2021). Similar approaches have been proposed to optimise last-mile distribution (Gutierrez-Franco, Mejia-Argueta, and Rabelo 2021) and inventory routing (Boru et al. 2019; Dosdoğru, İpek, and Göçken 2021) using anticipated demand or lead times. In addition to optimisation purposes, some studies have attempted to integrate machine learning and simulation into digital twins, with a particular focus on quality control. These innovations first appeared in the medical (Arshad, Vrieze, and Xu 2022) and agricultural (Melesse et al. 2022) fields, where product quality is critical to the supply chain. Such studies typically input local determinism estimated by machine learning into simulation models to explore the uncertainty on a holistic scale, which extend the scope of predictive analytics in the decision-making process.

In summary, existing research has initially explored ways to combine simulation and machine learning for predictive analytics. Innovative methods have been proposed to support various supply chain processes such as scheduling, routing, supplier selection, quality control, and risk management. Predictive information such as demand, performance, and risk are critical to the success of these supply chain processes. This trend is mainly driven by the constraints of data scarcity and the need for predictive information at different levels of granularity. The way in which simulation and machine learning are combined varies from study to study. Machine learning models can be developed using simulated data. Conversely, simulation parameters can be set based on machine learning predictions.

However, the challenges faced by predictive analytics in the VUCA world have not been adequately addressed in the literature. While some studies have attempted to mitigate the limitation of data scarcity, few have paid sufficient attention to the needs of timeliness and interpretability. This neglect makes it difficult for predictive analytics to cope with the growing external uncertainty and internal complexity that characterise modern supply chains. Therefore, three *objectives* were identified

through the presented literature review to address the *RQ* of this work, namely: ensuring timeliness, improving interpretability, and overcoming data scarcity. To this end, a novel integrated approach to predictive analytics is proposed and presented in the next section.

### 3. Proposal

To cope with the increasing uncertainty and complexity in contemporary supply chains, a novel integrated predictive analytics approach is proposed by coupling simulation and machine learning. This section firstly explains the overall architecture and technical details of the proposed method, followed by an in-depth discussion of the synergy between simulation and machine learning and the benefits it brings.

#### 3.1. The integrated predictive analytics approach

The inspiration for this work stemmed from an extensive examination of the current challenges in predictive analytics and a comprehensive review of the relevant literature. The former shaped the *RQ* to be addressed and the *objectives* to be achieved. The latter illuminated pathways for integrating simulation and machine learning. As shown in Figure 2, the overall architecture of the proposed approach consists of two phases: a build-time phase for constructing predictive models, and a run-time phase for performing predictive analytics using these models.

##### 3.1.1. The build-time phase

The build-time phase begins with the modelling of the supply chain system. In this step, simulation models are constructed using historical data generated by the system and the business understanding of the system. Depending on the supply chain process to simulate and the abstraction level of the simulation, different simulation methods such as system dynamics, discrete event simulation and agent-based modelling can be used. Historical data is used to calibrate simulation models. Experts can also evaluate the representativeness of these models based on their understanding of the business.

The simulation models are then executed in offline simulations to extrapolate possible scenarios not covered by historical data. Baseline scenarios are first defined based on historical data, then alternative scenarios can be developed by altering key variables. The extrapolated scenarios should be plausible, relevant and diverse. In this step, an integrated dataset is created by adding the simulated data from offline simulations to the historical data.

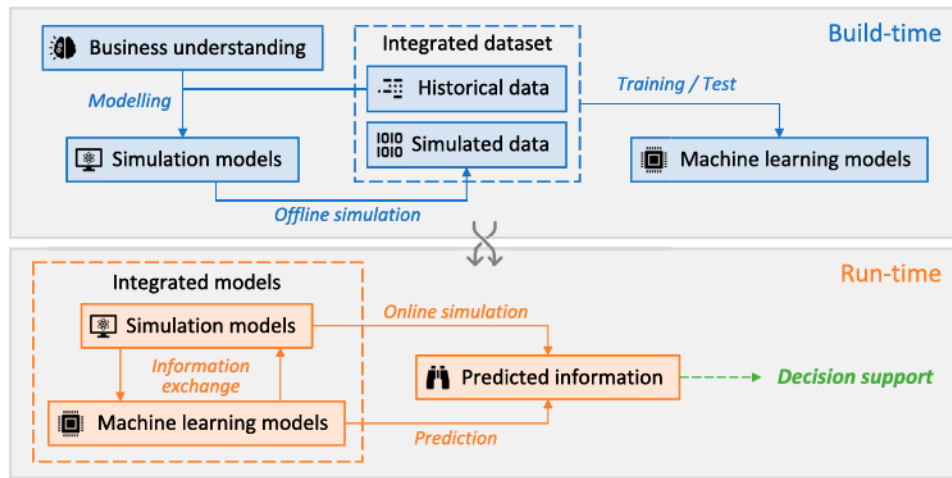

**Figure 2.** Schematic architecture of the integrated predictive analytics approach.

Machine learning models are then built using the integrated dataset, which is more comprehensive and representative than historical data alone. Depending on the predictive task, different supervised learning methods such as classification and regression can be used. At the end of the build-time phase, two types of predictive models, simulation-based and machine learning-based, are developed for subsequent analysis.

The validation process is crucial for assessing the reliability and understanding the limitations of these predictive models. There are three levels of credibility here. The historical data has the highest credibility, which is used to validate the simulation models. The simulated data has the secondary credibility, which is used along with the historical data to validate the machine learning models. The predictions made by machine learning are considered to be the least credible compared to others.

### 3.1.2. The run-time phase

The run-time phase involves the synergistic use of simulation-based and machine learning-based predictive models to provide predicted information and facilitate decision-making. Various predictive tasks can be performed in this phase. Simulation-based and machine learning-based models can be used to perform the same predictive task. They can also collaborate with each other to accomplish their different tasks.

In the former case, machine learning-based models can make timely predictions given a possible scenario. Such predictions are less interpretable. It is difficult to understand the cause of the prediction from a detailed perspective. To this end, online simulations can be conducted for the same scenario to provide additional information. For example, the simulated order fulfillment

process can be used to interpret the predicted lead times. The interpretability of predictions is thus improved thanks to the information flow from simulation to machine learning.

In the latter case, dependencies between different predictive tasks determine how the two types of models collaborate with each other. Machine learning-based models are good at predicting quantifiable variables, whereas simulation-based models excel in describing the interactions between different variables. Therefore, machine learning-based models are used to predict independent variables such as demand and delivery time. These predictions are then fed into online simulations to predict dependent variables such as fill rate and on-time delivery. This information flow from machine learning to simulation facilitates a more comprehensive anticipation of the future.

For predictive analytics, it is preferable to make probabilistic rather than deterministic predictions to characterise uncertainty. Machine learning algorithms such as Gaussian process regression can be used to develop probabilistic predictive models. For deterministic predictive models (either simulation-based or machine learning-based), Monte Carlo experiments can be performed to produce probabilistic results. Both can provide probability distributions rather than deterministic estimates.

### 3.2. The synergy between simulation and machine learning

The novelty of the integrated predictive analytics approach lies in the synergy between simulation and

machine learning. In the build-time phase, simulated data is used to enrich the historical data for developing machine learning models. In the run-time phase, simulation-based and machine learning-based models work together to perform either the same or different predictive tasks. Thanks to the synergy between simulation and machine learning, the proposed approach provides a viable way to achieve the three *objectives* identified in the literature review.

The timeliness of predictive analytics is ensured from two aspects. First, machine learning models are efficient at inference and can make timely predictions. Second, predictive models need to be updated in a timely manner to adapt to the evolving VUCA world. Machine learning is at a disadvantage in this regard because it takes time to collect historical data. Conversely, simulation is agile because even with limited historical data, simulation models can still be updated based on a prospective understanding of the business. Machine learning models can then adapt to the newly simulated data to ensure they are up to date.

Regarding interpretability, the more interpretable a predictive model is, the easier it is for someone to understand why certain predictions were made (Molnar 2023). Simulation models are intrinsically interpretable from this perspective. As simulated data is used to augment historical data, the machine learning model is trained to approximate the simulation model. Given the same scenario, the two would make consistent predictions. With the additional information provided by the simulation, it is easier to comprehend why the target supply chain would operate as predicted by the machine learning model. The local interpretability of a single prediction is thus improved in the supply chain context.

The data scarcity is addressed by generating synthetic data through simulations to supplement historical data. This process yields a more comprehensive representation of potential scenarios, allowing machine learning models to be trained on a diversified dataset. Distinguishing our approach, it not only performs data augmentation to increase the volume of available data but also delves into exploring a spectrum of potential scenarios via simulation. Contrary to merely transforming existing data, the synthetic data is grounded in simulation models that embed the business understanding of domain experts. This contextual data can describe the intricate interactions within complex systems, where data augmentation in the narrow sense fails.

To illustrate how to apply the proposed approach and how it meets the above *objectives*, a humanitarian supply chain case study is presented in the next section.

## 4. Case study

As a typical system challenged in the current VUCA world, the humanitarian organisation provides an apt context for the illustrative case study. We applied the proposed approach to a nationwide supply chain operated by the Indonesian Red Cross Society (Palang Merah Indonesia, PMI). By performing pre-crisis performance assessment, we illustrate how the integrated predictive analytics approach can help supply chains cope with the increasing external uncertainty and internal complexity.

### 4.1. The humanitarian supply chain

Due to the unpredictable nature of humanitarian crises, humanitarian organisations are constantly challenged by uncertainty. These organisations need to conduct preparedness activities during normal times to be able to respond quickly when a crisis occurs. Failures in humanitarian operations can result in irreversible losses, such as casualties. Predictive analytics is therefore critical to humanitarian organisations. Based on this consensus, projects such as Forecast-based Action (FBA) and Community Ready to Act (CoRTA) have been launched to improve the predictive capabilities of such organisations. With approximately 80% of relief operations related to logistics, humanitarian organisations typically operate supply chains to distribute relief supplies to affected areas and victims (Van Wassenhove 2006). To adapt to increasing uncertainty, humanitarian supply chains are becoming more complex as they proactively adopt advanced techniques to improve performance. Predictive analytics is struggling to keep pace with this trend.

#### 4.1.1. Indonesian red cross society

PMI was selected for this case study because of its representativeness in the humanitarian sector and its drive to improve predictive capabilities. As a member of the International Federation of Red Cross and Red Crescent Societies (IFRC), PMI is a major provider of humanitarian aid in Indonesia. As a developing country, Indonesia is prone to humanitarian crises due to its large population and frequent natural disasters. Efficient information acquisition and timely damage assessment are hampered by undeveloped infrastructure, which in turn slows down relief operations. One example is the delayed response to the 2004 Indian Ocean earthquake and tsunami, due to the lack of early warning systems at the time. Predictive analytics is crucial in such cases to inform anticipatory action, and PMI is making efforts in this direction.



**Figure 3.** The PMI humanitarian supply chain network.

To investigate how PMI operates its humanitarian supply chain, a field survey was conducted to gather historical data and business understanding (Grest, Lauras, and Montreuil 2019). The main activities can be divided into the preparedness stage and the response stage. A safety stock of relief supplies needs to be maintained during the preparedness stage, which will be distributed through the logistics network during the response stage.

The humanitarian supply chain network is shown in Figure 3, ranging from donors and suppliers to beneficiaries (Charles, Lauras, and Van Wassenhove 2010). Received aid is stored in a three-tier logistics network, consisting of regional, provincial and district warehouses. In normal times, pre-procurement and pre-positioning operations dynamically adjust the inventory allocation to meet preparedness needs. During humanitarian crises, temporary distribution points are dynamically established in affected areas. Relief supplies are then transported to these distribution points and finally handed over to the beneficiaries.

The performance of this humanitarian supply chain can be assessed from two perspectives: response coverage and response speed (Acimovic and Goentzel 2016; Beamon and Balcik 2008; Chakravarty 2021). The former reflects the ability to deliver aid on a continuous basis, while the latter reflects the waiting time for victims to receive aid. The inventory management strategy in the preparedness stage will result in different performance. Adequate inventory is a prerequisite to ensure response coverage, while proper inventory allocation helps to reduce the transport distance of supplies, thereby shortening lead times. During the response stage, different management strategies (see Table 1) can be used for sourcing, transport, replenishment and distribution, which also have a significant impact on performance.

#### 4.1.2. Dilemmas for predictive analytics

The analysis of PMI clearly shows that effective SCM is essential for achieving humanitarian aid goals. Different

combinations of management strategies will yield different response coverage and speed. Predictive analytics can be used to assess this impact in advance and help managers optimise supply chain operations accordingly. However, traditional approaches to predictive analytics have faced the following dilemmas.

The inherent uncertainty of humanitarian crises poses significant challenges in anticipating their occurrence and damage. Such uncertainty can be characterised by various patterns of aid demand, allowing for the construction and simulation of anticipatory scenarios. However, the timeliness of this predictive analytics approach is poor when there are too many potential scenarios to consider. It is also difficult to apply machine learning in this situation. Humanitarian crises are relatively infrequent compared to other supply chain disruptions, so historical data is scarce. The diversity of past and future crises makes it difficult to collect representative data, which also hampers such data-driven methods.

In addition, PMI is seeking to improve its performance by refining its SCM strategies (see Table 1). With the integration of advanced paradigms such as the Internet of Things and the Physical Internet, the supply chain components are becoming more interconnected (Bendaya, Hassini, and Bahroun 2019; Montreuil 2017). As the system becomes more flexible, it inevitably becomes more complex. This trend also leads to more complex and time-consuming simulation models, which further reduces the timeliness of simulation-based predictive analytics. As for machine learning, its black-box nature makes it difficult to link the predicted performance to the complex supply chain operations that lead to such performance. Increasing complexity makes machine learning predictions difficult to interpret, limiting their usefulness for decision support.

This case study applied the proposed approach to help PMI address the above dilemmas. By conducting pre-crisis performance assessment and analysing the results, we further illustrate how the proposed approach ensured timeliness, improved interpretability, and overcame data scarcity.



**Table 1.** The SCM strategies of PMI in the response stage.

Process	Strategy	
Sourcing	Traditional	Hierarchical sourcing <i>Unidirectional flow, from upstream to downstream.</i>
	Refined	Matrix sourcing <i>Bi-directional flow, both horizontal and vertical.</i>
Transport	Traditional	Dedicated deliveries <i>Single destination, return loaded empty.</i>
	Refined	Consolidated deliveries <i>Multiple destinations, improved load rate.</i>
Replenishment	Traditional	Long lead time <i>Approximately 15 days to complete the replenishment.</i>
	Refined	Short lead time <i>Approximately 3 days to complete the replenishment.</i>
Distribution	Traditional	First in first out (FIFO) <i>The first order are fulfilled first.</i>
	Refined	Equity <i>All orders are partially fulfilled by splitting inventory.</i>

## 4.2. The build-time phase

To apply the integrated predictive analytics approach, simulation-based and machine learning-based predictive models need to be constructed first. The build-time phase is divided into three steps: modelling, offline simulation, and machine learning.

### 4.2.1. Modelling

The aim of the modelling step is to construct simulation models which are then executed in the offline simulation to generate simulated data. A humanitarian supply chain simulation model developed in preliminary work is used in this study, more details can be found in Grest et al. (2021). The supply chain operations performed by PMI during the response stage are summarised as a set of processes and modelled using agent-based discrete event simulation. The internal logic of the simulation model can be explained by its architecture, which is shown in Figure 4.

The simulation model consists of a *scenario configurator*, a *virtual humanitarian operating environment*, and a *performance monitor*. As a result of preparedness activities in normal times, the initial inventory

allocations for the response stage can be set using the *scenario configurator*. In addition to the inventory, the *scenario configurator* is also used to define the crisis characteristics and management strategies that serve as inputs to the simulation. Given a specific scenario, the *virtual humanitarian operating environment* first injects the disaster into the affected territory. The demand for aid is then generated and fulfilled through a series of humanitarian operations. At the same time, the *performance monitor* records the performance of the humanitarian supply chain by tracking multiple indicators.

The historical data collected during the field survey on PMI is mainly used in the modelling step. Some of the historical data, such as the locations and capacities of warehouses, are employed to define the simulation model. Others, such as the speed and loading limits of trucks, are used to set simulation parameters. As PMI did not adopt refined management strategies at the time, the historical lead times and demand coverage are used to validate the model when simulating traditional management strategies. More details can be found in the preliminary work (Zhang et al. 2023).

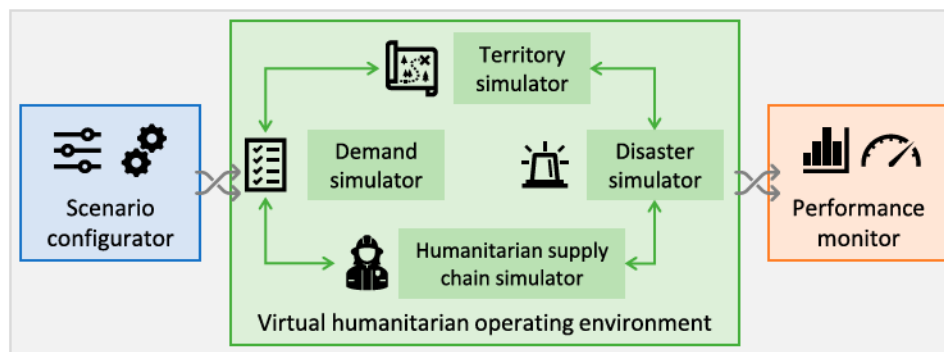

**Figure 4.** The humanitarian supply chain simulation model (Grest et al. 2021; Zhang et al. 2023).

#### 4.2.2. Offline simulation

Offline simulation is used to explore potential scenarios and collect simulated data, ensuring that subsequent machine learning models are trained and tested on a more comprehensive and representative dataset. Therefore, twelve combinations of different management strategies (see Table 1) are simulated in this step. Note that the concurrent application of hierarchical sourcing and consolidated deliveries was considered infeasible in this case study.

For each combination of different management strategies, 1,000 different scenarios with different initial inventories and disaster intensities are constructed. Thus, a total of 12,000 potential scenarios are simulated in the offline simulation step. Each scenario can be characterised by the following features:

- (1) The final cumulative demand  $d_N$  on day  $N$  (the end of the response stage), determined by randomly generated disaster intensity that follows a Gaussian distribution.<sup>1</sup>
- (2) The initial inventory  $i_w$  for each warehouse ( $w \in \mathcal{W}, \mathcal{W} = \{1, 2, \dots, M\}$ ), randomly assigned to reflect the results of the pre-procurement and pre-positioning in normal times.
- (3) The management strategies  $s$  for sourcing ( $s_s$ ), transport ( $s_t$ ), replenishment ( $s_r$ ), and distribution ( $s_d$ ).

The diversity of offline simulation inputs ensures the comprehensiveness of the simulated dataset. To assess the response performance of the humanitarian supply chain at different time scales, two indicators (short-term and long-term) are collected in the offline simulation. The short-term performance indicator is the *cumulative*

delivery  $p_t$  in percentage form, defined as follows:

$$p_t = \min(d_t, s_t) / d_t \quad (1)$$

where  $t$  is the time in days since the onset of the disaster,  $d_t$  is the cumulative demand up to day  $t$ , and  $s_t$  is the cumulative delivery up to day  $t$ .  $p_t$  can be seen as the result of the implementation of relief operations. The response coverage accumulated up to day  $t$  can be represented directly by  $p_t$ , and the response speed can be described by the slope ( $dp_t/dt$ ) of the time series curve of  $p_t$ . The long-term performance indicator is the *readiness*  $r$  in percentage form, defined as follows (Inan et al. 2020):

$$r = \sum_{t \in \mathcal{T}} 1/N \times p_t \quad (2)$$

where  $\mathcal{T} = \{1, 2, \dots, N\}$  is the specific time period considered to be the response stage following the onset of the disaster. *Readiness*  $r$  is a comprehensive metric that provides a simple and overall measure of humanitarian supply chain performance. A value of  $r$  close to 0% indicates a failure to deliver due to insufficient resource availability or transport capacity, while a value of  $r$  close to 100% indicates both good coverage and speed of response.

The distributions of the simulated performance indicators are shown in Figure 5. From the trends in the *cumulative delivery*  $p_t$  curve, we can see that the simulated dataset covers various potential scenarios with different response coverage and speed performance. The 1/4 quantile curve represents the situation with low response coverage in the first ten days, while the mean curve indicates the situation with poor response speed in the second week after the disaster. The 3/4 quantile curve can be seen as an example of good performance in both aspects. Accordingly, the comprehensive *readiness*

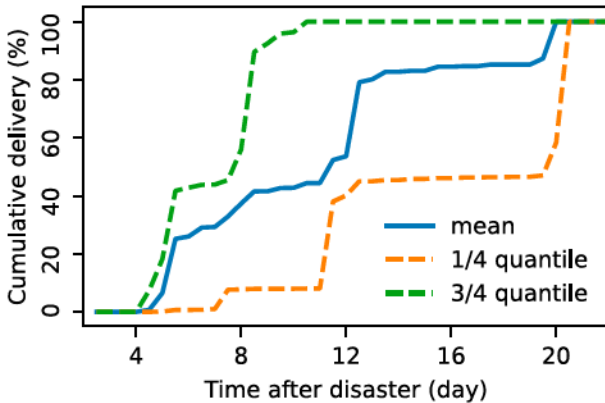

(a) Cumulative delivery.

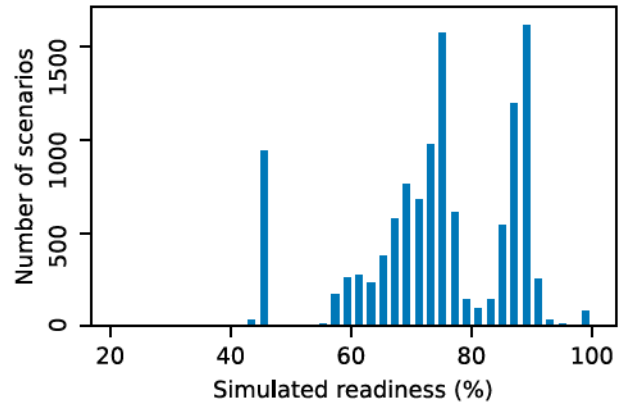

(b) Readiness.

Figure 5. The simulated dataset. (a) Cumulative delivery and (b) Readiness.

indicator  $r$  covers a range from 20% to almost 100%. The distributions of both indicators reveal the representativeness of the simulated dataset, ensuring the generalisation of the subsequent machine learning models. For a more in-depth analysis of the simulated dataset, see the preliminary work (Zhang et al. 2023).

### 4.2.3. Machine learning

In this step, two machine learning models are developed using the simulated dataset obtained from the previous offline simulation. The goal of the two models is to predict the two indicators, *readiness*  $r$  to assess relatively long-term performance and *cumulative delivery*  $p_t$  to track relatively short-term performance. There are two types of input to both models.

- (1) The scenario feature tensor  $\mathbf{f}$  consists of the final cumulative demand  $d_N$  (normalised to a standard Gaussian distribution), the initial inventory  $[i_1, i_2, \dots, i_M]$  (normalised to a standard Gaussian distribution), and the management strategies  $[s_s, s_t, s_r, s_d]$  (encoded using simple binary encoding).
- (2) The cumulative delivery tensor  $\mathbf{p} = [p_1, p_2, \dots, p_n]$  for the previous  $n$  days, where  $n$  is variable. This input can be either from an online simulation in the run-time phase, or from real data collected in the early response stage.

Two artificial neural networks are constructed for the machine learning models, based on the 1-dimensional (1D) convolutional layers and the long short-term memory (LSTM) cells, respectively. Figure 6 shows the neural network architectures implemented using PyTorch. The design process of the prediction networks is divided into two steps: determining the basic architecture and setting the hyper-parameters. The basic architecture is tailored to the specific prediction tasks. For predicting *readiness*  $r$ , the 1D convolutional layers can process successive features of different lengths and use information such as adjacency that is determined by the order of the features. The rectified linear unit (ReLU) is used to ensure better gradient propagation in the build-time phase and efficient computation in the run-time phase. For predicting *cumulative delivery*  $p_t$ , the LSTM cells can retain long-term memory, which is critical for processing time series data. After determining the basic architecture, the hyper-parameters of the prediction networks were set by performing a grid search on a randomly sampled subset of the simulated dataset using 3-fold cross-validation. The models were then trained and evaluated on the entire dataset. The mean absolute error was used to assess the

prediction accuracy, which is presented in the next subsection.

The *readiness* prediction network first extracts latent features from the cumulative delivery tensor  $\mathbf{p}$ , then concatenates them with the scenario feature tensor  $\mathbf{f}$  for the subsequent prediction. Through this neural network, the overall readiness  $r$  of humanitarian supply chains can be predicted before the end of the simulated or real response stage. The length of the cumulative delivery tensor  $\mathbf{p}$  is flexible. A longer input requires a longer wait for the online simulation or real data collection, but more information will be available to the neural network, so more accurate predictions can be expected.

Unlike the *readiness* prediction network, the *cumulative delivery* prediction network can continuously predict the *cumulative delivery* curve in a rolling manner. Forecasting  $p_t$  requires the input of  $\mathbf{p} = [p_{t-n}, \dots, p_{t-1}]$ , which can come from online simulation, real data or previous forecasts. A complete *cumulative delivery* curve in the response stage can help managers to make better decisions on appropriate adjustment measures compared to the single *readiness* value.

## 4.3. The run-time phase

Using the predictive models developed in the build-time phase, predictive analytics of humanitarian supply chain performance can be performed in the run-time phase. Given a particular potential scenario, the online simulation is run first. As the simulation takes a relatively long time, the machine learning models step in when the online simulation reaches the  $n^{\text{th}}$  day. The performance indicators (*readiness* and *cumulative delivery*) are predicted by the machine learning models before the online simulation is completed. At the end of the online simulation, the simulated supply chain operations are used to explain the cause of such predicted performance under this scenario. By coupling simulation and machine learning in the proposed approach, the machine learning models enable continuous forecasting with better timeliness, while the online simulation guarantees the interpretability of the projected future. Two examples are given below.

### 4.3.1. Long-term prediction: readiness

The *readiness* prediction network is used to predict the relatively long-term performance of the humanitarian supply chain in the response stage. Figure 7(a) shows the results of the proposed approach applied to an example scenario. First, the online simulation is run to simulate the post-disaster response of the humanitarian supply chain. As the online simulation takes a relatively long

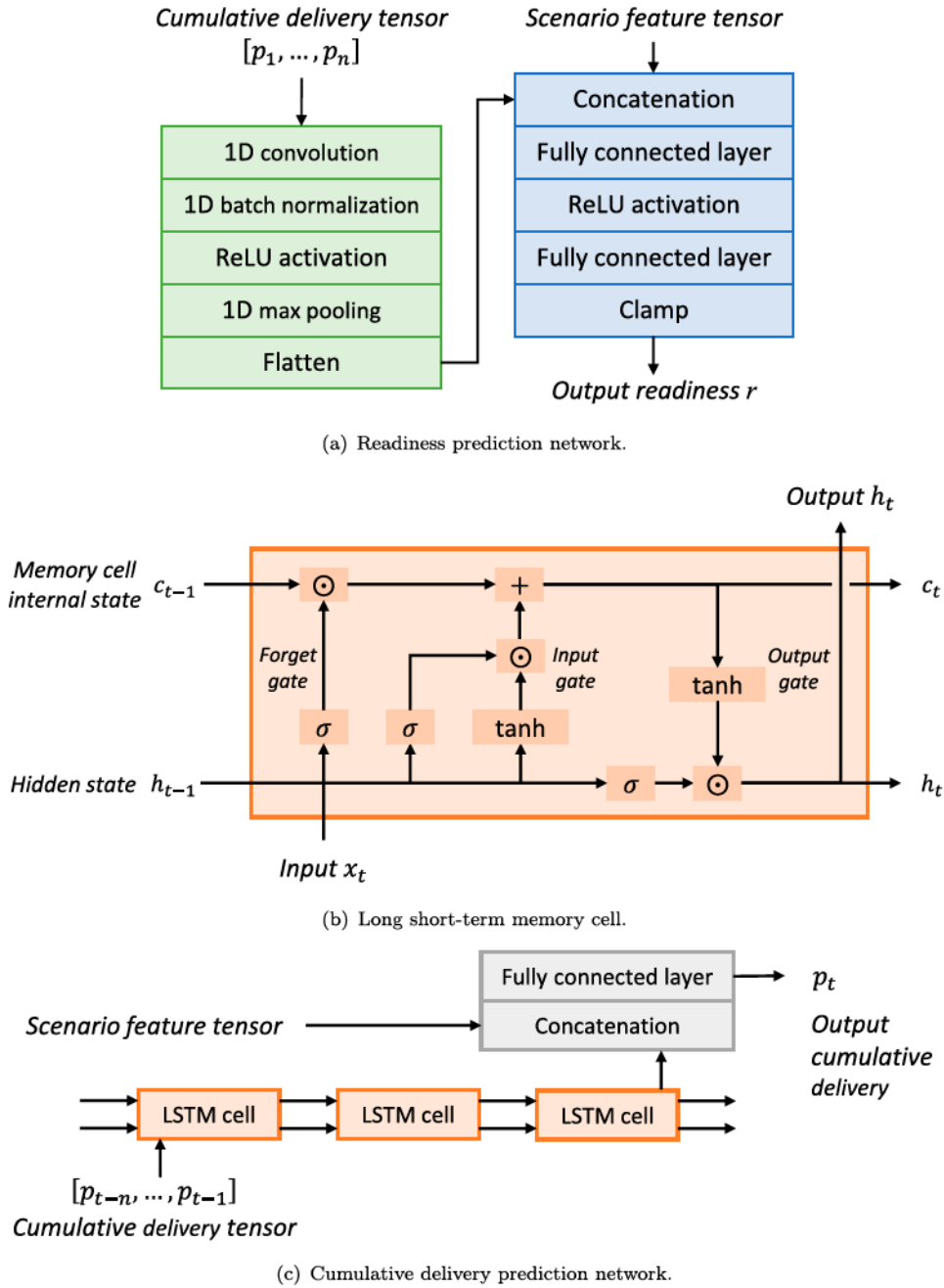

**Figure 6.** The neural network architectures. (a) Readiness prediction network. (b) Long short-term memory cell and (c) Cumulative delivery prediction network.

time, the *readiness* prediction network starts to make predictions when the online simulation progresses to the  $n^{\text{th}}$  day after the disaster. The predicted *readiness* from this machine learning model allows managers to assess long-term performance before the end of the simulated (or real) response stage, thus improving the timeliness of predictive analytics. In addition, Figure 7(b) shows that the prediction error<sup>2</sup> of the machine learning model decreases as  $n$  increases, providing managers with a trade-off between accuracy and timeliness of predictive

information. When the online simulation is complete, the simulated relief operations provide a bridge to link inputs to outputs, helping managers understand how the humanitarian supply chain achieves the predicted *readiness* in this scenario.

#### 4.3.2. Short-term prediction: cumulative delivery

The *cumulative delivery* prediction network is used to predict the relatively short-term performance of the humanitarian supply chain in the response stage.

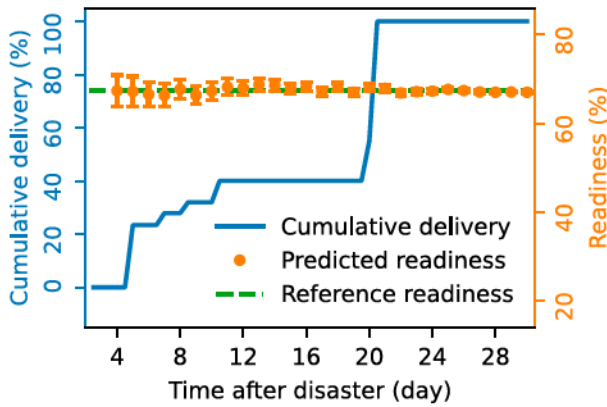

(a) Prediction of an example scenario.

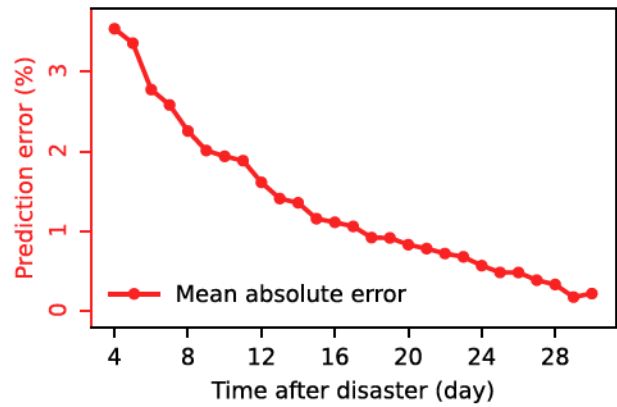

(b) Prediction error.

**Figure 7.** The readiness prediction. (a) Prediction of an example scenario and (b) Prediction error.

Figure 8(a) shows the results of the proposed approach applied to an example scenario. Similar to the long-term prediction, the online simulation is first run to provide the *cumulative delivery* for the first  $n$  days, which is then fed into the *cumulative delivery* prediction network as input. The machine learning model can then predict the subsequent *cumulative delivery* curve in a rolling manner. Figure 8(b) shows that the prediction error<sup>3</sup> for *cumulative delivery* does not exhibit a monotonically increasing or decreasing trend with respect to  $n$ . Therefore, extending the waiting period to increase  $n$  is not essential for obtaining a more accurate prediction.

As noted previously, daily delivery reflects short-term performance. The *cumulative delivery* curve provides more detail than a single measure of *readiness*. Without the machine learning model, the full curve is not available until the end of the online simulation. Figure 9 shows the time cost of different predictive models. The simulation-based model is much slower than the machine learning-based ones. However, with the

proposed approach, machine learning can predict *readiness* and the corresponding *cumulative delivery* curve almost simultaneously before the online simulation is completed. This further improves timeliness.

#### 4.4. Case study summary

In summary, the proposed integrated predictive analytics approach is applied to a humanitarian supply chain operated by the PMI. This case study demonstrates how simulation and machine learning are coupled to provide predictive analytics in an increasingly uncertain and complex context. Furthermore, the three *objectives* of this research are well met thanks to the complementarity between simulation and machine learning. Data scarcity is overcome by enriching the dataset with simulated data from the offline simulation. The interpretability is guaranteed by the online simulation, while the timeliness is improved by the machine learning predictions.

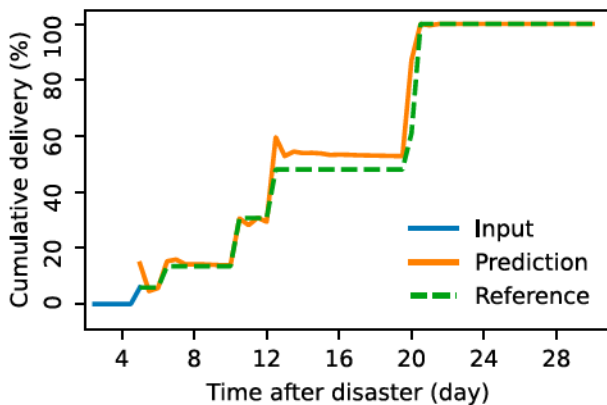

(a) Prediction of an example scenario.

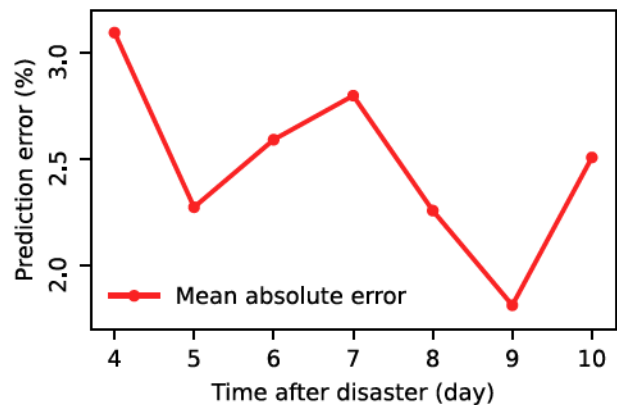

(b) Prediction error.

**Figure 8.** The cumulative delivery prediction. (a) Prediction of an example scenario and (b) Prediction error.

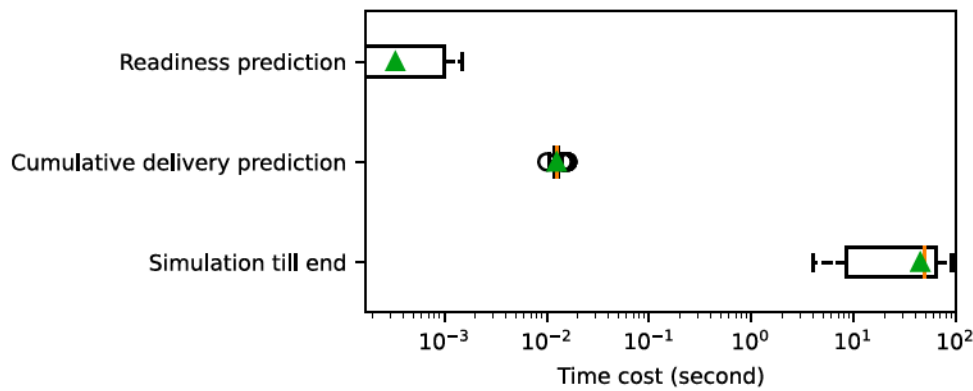

**Figure 9.** Time cost of different predictive models.

Understanding why the humanitarian supply chain would achieve the predicted performance in a given scenario is vital for adjusting decisions. It's difficult to explain the relationship between inputs (demands, inventories, and strategies) and outputs (performance indicators) for machine learning models. However, with the additional information (supply chain operations executed in the simulation), it's possible to link the predicted performance to certain supply chain-related factors. Good performance can be attributed to adequate inventory or timely replenishment. Poor performance may be due to inappropriate routing or waste of transport resources. Since all the detailed supply chain operations during the simulation are known, such information provides a clue to understanding how the particular demands, inventories, and strategies produce the predicted performance. This improved interpretability makes the predictions more valuable for decision support.

In addition, timely and accurate decision-making is critical to the success of humanitarian relief operations. The case study above illustrates how the proposed approach can help humanitarian organisations to analyse their performance under different possibilities before a disaster occurs. Improved timeliness is an important benefit of the proposed approach in the humanitarian context. From Figure 9, we can see that a full simulation in this case typically takes more than 10 seconds, while a machine learning model takes about 0.01 seconds to make a prediction. When there are 12,000 potential scenarios to consider, the difference between the two in terms of time cost is magnified to 1 day versus 2 minutes. As uncertainty and complexity increase, the improvement in timeliness becomes more significant.

Although the strength of the proposed approach is demonstrated through this case study, the limitations and challenges of implementing the approach cannot be ignored. Building simulation models requires a thorough understanding of the target system, otherwise

the representativeness of the resulting models cannot be guaranteed. Scenario extrapolation needs to be both plausible and comprehensive, which is difficult to balance. The expertise required to apply advanced machine learning techniques is also a relatively scarce resource in the humanitarian sector. How to integrate the predicted information into the decision-making process and enable anticipatory action remains to be investigated.

## 5. Conclusions and perspectives

Predictive analytics is critical to the success of SCM, yet challenging in the VUCA world. Traditional approaches struggle to adapt to the increasing uncertainty and complexity that characterise modern supply chains. The implementation of predictive analytics is limited by data scarcity, while the value of predictive information is diminished by insufficient timeliness and interpretability. To address these challenges, this study presents a novel integrated predictive analytics framework that synergistically leverages the strengths of simulation and machine learning techniques. Through a comprehensive case study of the Indonesian Red Cross humanitarian supply chain, we demonstrate the viability and efficacy of the proposed approach and emphasise its potential to significantly enhance the decision-making process.

The contribution of our work can be summarised in two aspects: theoretical and practical. The theoretical contribution lies in the extensive review of the SCM literature, which identified the trend towards combining simulation and machine learning to address the challenges of predictive analytics. Inspired and motivated by this trend, we developed the integrated predictive analytics approach, which further exploits the synergy between simulation and machine learning to support modern supply chains in managing the internal complexity and navigating the uncertain environment. The

superiority of this synergy is manifold. Firstly, it alleviates data scarcity by generating simulated data through scenario extrapolation to complement historical data. Secondly, it enhances the timeliness of predictive analytics through agile update of simulation models and efficient inference of machine learning models. Moreover, our study elevates the interpretability of predictive analytics – a critical yet often overlooked aspect in the existing literature – by using additional information from simulation to interpret machine learning predictions in supply chain contexts.

The practical implications of our work are initially illustrated by a humanitarian supply chain case study. The implementation of our approach enables a comprehensive and timely assessment of response performance under uncertainty, providing humanitarian organisations with invaluable pre-crisis insight to inform their decisions. Beyond the humanitarian context, enhanced predictive capabilities enable supply chain managers to make proactive decisions and practitioners to take anticipatory actions. This improvement will make supply chains to be more resilient to disruption and more agile to adapt to the VUCA world. Despite the innovation of the proposed approach, the challenges at the implementation level cannot be ignored. Applying the proposed predictive analytics approach requires expertise in simulation modelling and machine learning, which is still scarce in humanitarian and industrial sectors. The business understanding required to develop predictive models can limit their reusability across different enterprises and supply chain systems. Integrating predictive analytics into existing decision-making processes also remains to be investigated.

To amplify the implications of this work, several avenues for future research are identified. A promising direction is the integration of optimisation techniques with our proposed predictive analytics approach. This would allow for a transition from predictive to prescriptive analytics. Our approach could serve as a component of the optimisation process to provide predictive information. This information can be used to guide the search algorithms when applying heuristic algorithms, or to formulate the objective functions in mathematical programming. This integration, however, presents several challenges. First, optimisation models need to effectively incorporate probabilistic predictions and adequately account for the errors in such predictions. Second, access to real-time data is critical to ensure that predictions and optimisations are adaptive and responsive. Finally, the integration must consider the computational feasibility, particularly under conditions of high uncertainty. By overcoming these challenges, the combination of simulation, machine learning, and optimisation

could effectively promote the proactive and predictive decision-making in supply chain management.

Integrating our approach with digital twins also presents a transformative opportunity. Our approach could enrich digital twins with advanced predictive capabilities, enabling them to operate not only in real time, but also in predicted future scenarios. This dual-state operation could improve decision-making in various supply chain aspects. For example, it can enable proactive inventory adjustments based on demand forecasts, anticipatory logistics planning to mitigate potential disruptions, and strategic resource allocation for maximum efficiency. By comparing the predicted future with desired objectives, supply chain managers could make proactive decisions that align closely with strategic goals. In addition to enhancing digital twins, predictive analytics could also benefit from the dynamic feedback mechanisms of digital twins. This enhancement involves continuously updating predictive models with live data feeds from supply chain operations, allowing for real-time responsiveness. This improvement enables predictive analytics to quickly adapt to the evolving external environment, allowing supply chains to timely adjust to uncertainties such as supply disruptions and demand fluctuations.

## Notes

1. The mean is 22,510 and the standard deviation is 3,330.
2. The prediction error is evaluated using mean absolute error. The unit is the same as the unit of the readiness, which is a percentage.
3. Similar to Figure 7(b), the unit of the prediction error is the same as the unit of the cumulative delivery, which is a percentage.

## Disclosure statement

No potential conflict of interest was reported by the author(s).

## Funding

This work was supported by the Agence Nationale de la Recherche (grant number CARNOT 2021 - AAP 13).

## Notes on Contributors



*Tianyuan Zhang* is an Assistant Professor in the Operations Management and Information Systems Department at KEDGE Business School. He received his bachelor's degree in Information Engineering from Beihang University and his Ph.D. in Cartology & Geographic Information System from Peking University. His research interests lie in the application of data science and machine learning to industrial engineering. This work is mainly done

during his postdoctoral project at IMT Mines Albi, focusing on the synergy of simulation and machine learning for decision support in SCM. Tianyuan Zhang is the corresponding author of this paper and his email address is: tianyuan.zhang@kedgebs.com.



**Matthieu Lauras** is a Full Professor and Head of the Industrial Engineering Center at IMT Mines Albi. He is the Pierre Fabre 'Agile Supply Chain' Chair and the Scientific Director of various public-private joint research labs and research projects. He is Adjunct-Professor at Georgia Tech ISyE and Beijing Jiaotong University SEM.

His research develops contributions to help stakeholders in collaborative networks make better decisions in uncertain and/or disruptive environments. His research activities concern both industrial management systems and crisis management systems such as humanitarian supply chains. His email address is: matthieu.lauras@mines-albi.fr.



**Gregory Zacharewicz** is a Full Professor at IMT Mines Alès. He joined the LGI2P laboratory in 2018 to develop research based on simulation. He was previously an Associate Professor at University of Bordeaux (2007–2018). He obtained his Ph.D. from University Paul Cézanne / Aix-Marseille III (2006) and his engineering degree from

Ecole Polytechnique Universitaire de Marseille (2002). His research interests lie in modelling, interoperability and simulation of business and social organisations, with a general focus on distributed discrete event modelling, ERP, BPMN and workflow. His email address is: gregory.zacharewicz@mines-ales.fr.



**Souad Rabah** is an Associate Professor at the Laboratory for the Science of Risks of IMT Mines Alès. She was previously an ATER (Attaché Temporaire d'Enseignement et de Recherche) at the Ampère Laboratory of the Electrical Department of Institut National des Sciences Appliquées de Lyon. She holds a

doctoral degree from Université de Picardie Jules Verne in Engineering Sciences in 2017. She was responsible for the development of the Digital Twin in the framework of the Chair of Electrical Transfer of ESIEE Amiens 2016–2018. Her research focuses on control of industrial systems, mechatronics and digital twins based on systems engineering approach. Her email address is souad.rabah-chaniour@mines-ales.fr.





**Frederick Benaben** is a Full Professor at the Industrial Engineering Center of IMT Mines Albi, and is also an Adjunct-Professor at Georgia Tech ISyE and Beijing Jiaotong University SEM. He holds a Ph.D. in Computer Science from University of Montpellier. He is the director of the IOMEGA-VR lab (Immersive Technologies for Security), and the co-director of the international lab SIREN (Sentient Immersive Response Network), which is a collaboration between IMT Mines Albi and Georgia Tech ISyE. He works on the use of data to model unstable situations and the use of artificial intelligence to support

decision-making and security management. He has extensive experience in research collaboration with industry over the last 15 years, including publicly funded research projects and industry-private common research labs. His email address is frederick.benaben@mines-albi.fr.

## ORCID

Tianyuan Zhang  <http://orcid.org/0000-0001-9104-0830>

Matthieu Lauras  <http://orcid.org/0000-0003-2901-4038>

Gregory Zacharewicz  <http://orcid.org/0000-0001-7726-1725>

Souad Rabah  <http://orcid.org/0000-0003-2155-5737>

Frederick Benaben  <http://orcid.org/0000-0002-1676-6524>

## References

- Abideen, Ahmed Zainul, Veera Pandiyan Kaliani Sundram, Jaafar Pyeman, Abdul Kadir Othman, and Shahryar Sorooshian. 2021. "Digital Twin Integrated Reinforced Learning in Supply Chain and Logistics." *Logistics* 5 (4): 84. <https://doi.org/10.3390/logistics5040084>.
- Acimovic, Jason, and Jarrod Goentzel. 2016. "Models and Metrics to Assess Humanitarian Response Capacity." *Journal of Operations Management* 45 (1): 11–29. <https://doi.org/10.1016/j.jom.2016.05.003>.
- Arshad, Rushan, Paul de Vrieze, and Lai Xu. 2022. "Incorporating a Prediction Engine to A Digital Twin Simulation for Effective Decision Support in Context of Industry 4.0." In *Collaborative Networks in Digitalization and Society 5.0: 23rd IFIP WG 5.5 Working Conference on Virtual Enterprises (PRO-VE), Lisbon, Portugal*, 67–76. Springer.
- Badakhshan, Ehsan, and Peter Ball. 2022. "Applying Digital Twins for Inventory and Cash Management in Supply Chains Under Physical and Financial Disruptions." *International Journal of Production Research* 61 (15): 5094–5116. <https://doi.org/10.1080/00207543.2022.2093682>.
- Baryannis, George, Sahar Validi, Samir Dani, and Grigoris Antoniou. 2019. "Supply Chain Risk Management and Artificial Intelligence: State of the Art and Future Research Directions." *International Journal of Production Research* 57 (7): 2179–2202. <https://doi.org/10.1080/00207543.2018.1530476>.
- Beamon, Benita M., and Burcu Balcik. 2008. "Performance Measurement in Humanitarian Relief Chains." *International Journal of Public Sector Management* 21 (1): 4–25. <https://doi.org/10.1108/09513550810846087>.
- Ben-Daya, Mohamed, Elkafi Hassini, and Zied Bahrour. 2019. "Internet of Things and Supply Chain Management: A Literature Review." *International Journal of Production Research* 57 (15-16): 4719–4742. <https://doi.org/10.1080/00207543.2017.1402140>.
- Blackhurst, Jennifer, M. Johnny Rungtusanatham, Kevin Scheibe, and Saurabh Ambulkar. 2018. "Supply Chain Vulnerability Assessment: A Network Based Visualization and Clustering Analysis Approach." *Journal of Purchasing and Supply Management* 24 (1): 21–30. <https://doi.org/10.1016/j.pursup.2017.10.004>.
- Boru, Asli, Ayşe Tuğba Dosdoğru, Mustafa Göçken, and Rızzvan Erol. 2019. "A Novel Hybrid Artificial Intelligence Based Methodology for the Inventory Routing Problem." *Symmetry* 11 (5): 717. <https://doi.org/10.3390/sym11050717>.



- Brahami, Menaouer, Abdeldjouad Fatma Zahra, Sabri Mohamed, Khalissa Semaoune, and Nada Matta. 2022. "Forecasting Supply Chain Demand Approach Using Knowledge Management Processes and Supervised Learning Techniques." *International Journal of Information Systems and Supply Chain Management* 15 (1): 1–21. <https://doi.org/10.4018/IJISSCM>.
- Cavalcante, Ian M., Enzo M. Frazzon, Fernando A. Forcellini, and Dmitry Ivanov. 2019. "A Supervised Machine Learning Approach to Data-Driven Simulation of Resilient Supplier Selection in Digital Manufacturing." *International Journal of Information Management* 49: 86–97. <https://doi.org/10.1016/j.ijinfomgt.2019.03.004>.
- Chakravarty, Amiya K. 2021. "Humanitarian Response to Disasters with Funding Uncertainty: Alleviating Deprivation with Bridge Finance." *Production and Operations Management* 30 (9): 3284–3296. <https://doi.org/10.1111/poms.13436>.
- Charles, Aurelie, Matthieu Laurus, and Luk Van Wassenhove. 2010. "A Model to Define and Assess the Agility of Supply Chains: Building on Humanitarian Experience." *International Journal of Physical Distribution & Logistics Management* 40 (8-9): 722–741. <https://doi.org/10.1108/09600031011079355>.
- Dev, Navin K., Ravi Shankar, Rachita Gupta, and Jingxin Dong. 2019. "Multi-Criteria Evaluation of Real-Time Key Performance Indicators of Supply Chain with Consideration of Big Data Architecture." *Computers & Industrial Engineering* 128: 1076–1087. <https://doi.org/10.1016/j.cie.2018.04.012>.
- Dosdoğru, Ayşe Tuğba, Aslı Boru İpek, and Mustafa Göçken. 2021. "A Novel Hybrid Artificial Intelligence-Based Decision Support Framework to Predict Lead Time." *International Journal of Logistics Research and Applications* 24 (3): 261–279. <https://doi.org/10.1080/13675567.2020.1749249>.
- Dwivedi, Yogesh K., Laurie Hughes, Elvira Ismagilova, Gert Aarts, Crispin Coombs, Tom Crick, and Yanqing Duan. 2021. "Artificial Intelligence (AI): Multidisciplinary Perspectives on Emerging Challenges, Opportunities, and Agenda for Research, Practice and Policy." *International Journal of Information Management* 57: 101994. <https://doi.org/10.1016/j.ijinfomgt.2019.08.002>.
- Feki, Mondher, Imed Boughzala, and Samuel Fosso Wamba. 2016. "Big Data Analytics-Enabled Supply Chain Transformation: A Literature." In *49th Hawaii International Conference on System Sciences (HICSS)*, Hawaii, USA, 1123–1132.
- Gao, Ying, Zhuo Feng, and Shuibo Zhang. 2021. "Managing Supply Chain Resilience in the Era of VUCA." *Frontiers of Engineering Management* 8 (3): 465. <https://doi.org/10.1007/s42524-021-0164-2>.
- Grest, Manon, Mahmut Metin Inan, Yaarit M. Cohen, Ali V. Barenji, Mathieu Dahan, Matthieu Laurus, and Benoit Montreuil. 2021. "Design of A Simulation-Based Experiment for Assessing the Relevance of the Physical Internet Concept for Humanitarian Supply Chains." In *8th International Physical Internet Conference (IPIC), Virtual*, 1–10.
- Grest, Manon, Matthieu Laurus, and Benoit Montreuil. 2019. "Toward Humanitarian Supply Chains Enhancement by Using Physical Internet Principles." In *2019 International Conference on Industrial Engineering and Systems Management (IESM), Shanghai, China*, 1–6. IEEE.
- Grzybowska, Katarzyna, and Agnieszka A. Tubis. 2022. "Supply Chain Resilience in Reality VUCA—An International Delphi Study." *Sustainability* 14 (17): 10711. <https://doi.org/10.3390/su141710711>.
- Gunasekaran, Angappa, Thanos Papadopoulos, Rameshwar Dubey, Samuel Fosso Wamba, Stephen J. Childe, Benjamin Hazen, and Shahriar Akter. 2017. "Big Data and Predictive Analytics for Supply Chain and Organizational Performance." *Journal of Business Research* 70: 308–317. <https://doi.org/10.1016/j.jbusres.2016.08.004>.
- Gutierrez-Franco, Edgar, Christopher Mejia-Argueta, and Luis Rabelo. 2021. "Data-Driven Methodology to Support Long-Lasting Logistics and Decision Making for Urban Last-Mile Operations." *Sustainability* 13 (11): 6230. <https://doi.org/10.3390/su13116230>.
- Hahn, Gerd J., and Josef Packowski. 2015. "A Perspective on Applications of In-Memory Analytics in Supply Chain Management." *Decision Support Systems* 76: 45–52. <https://doi.org/10.1016/j.dss.2015.01.003>.
- Heger, Jens, Jürgen Branke, Torsten Hildebrandt, and Bernd Scholz-Reiter. 2016. "Dynamic Adjustment of Dispatching Rule Parameters in Flow Shops with Sequence-Dependent Set-Up Times." *International Journal of Production Research* 54 (22): 6812–6824. <https://doi.org/10.1080/00207543.2016.1178406>.
- Huang, Ming-Guan. 2009. "Real Options Approach-Based Demand Forecasting Method for A Range of Products with Highly Volatile and Correlated Demand." *European Journal of Operational Research* 198 (3): 867–877. <https://doi.org/10.1016/j.ejor.2008.10.002>.
- Huber, Jakob, and Heiner Stuckenschmidt. 2020. "Daily Retail Demand Forecasting Using Machine Learning with Emphasis on Calendric Special Days." *International Journal of Forecasting* 36 (4): 1420–1438. <https://doi.org/10.1016/j.ijforecast.2020.02.005>.
- Hürkamp, André, Sebastian Gellrich, Tim Ossowski, Jan Beuscher, Sebastian Thiede, Christoph Herrmann, and Klaus Dröder. 2020. "Combining Simulation and Machine Learning As Digital Twin for the Manufacturing of Overmolded Thermoplastic Composites." *Journal of Manufacturing and Materials Processing* 4 (3): 92. <https://doi.org/10.3390/jmmp4030092>.
- Inan, Mahmut Metin, Benoit Montreuil, Mohammed Faisal Ahmed, and Matthieu Laurus. 2020. "Humanitarian Response Readiness Metric for More Effective Relief Operations." In *8th International Conference on Information Systems, Logistics and Supply Chain (ILS)*, 381–388. Austin, Texas, United States.
- Kaelbling, Leslie Pack, Michael L. Littman, and Andrew W. Moore. 1996. "Reinforcement Learning: A Survey." *Journal of Artificial Intelligence Research* 4: 237–285. <https://doi.org/10.1613/jair.301>.
- Kamble, Sachin S., and Angappa Gunasekaran. 2020. "Big Data-Driven Supply Chain Performance Measurement System: A Review and Framework for Implementation." *International Journal of Production Research* 58 (1): 65–86. <https://doi.org/10.1080/00207543.2019.1630770>.
- Kantasa-Ard, Anirut, Maroua Nouiri, Abdelghani Bekrar, Abdessamad Ait el Cadi, and Yves Sallez. 2021. "Machine Learning for Demand Forecasting in the Physical Internet: A Case Study of Agricultural Products in Thailand."

- International Journal of Production Research* 59 (24): 7491–7515. <https://doi.org/10.1080/00207543.2020.1844332>.
- Lang, Sebastian, Maximilian Kuetgens, Paul Reichardt, and Tobias Reggelin. 2021. "Modeling Production Scheduling Problems As Reinforcement Learning Environments Based on Discrete-Event Simulation and OpenAI Gym." *IFAC-PapersOnLine* 54 (1): 793–798. <https://doi.org/10.1016/j.ifacol.2021.08.093>.
- Le, Hai Quoc, Somjit Arch-Int, Huy Xuan Nguyen, and Ngam-nij Arch-Int. 2013. "Association Rule Hiding in Risk Management for Retail Supply Chain Collaboration." *Computers in Industry* 64 (7): 776–784. <https://doi.org/10.1016/j.com-pind.2013.04.011>.
- Lee, In, and George Mangalaraj. 2022. "Big Data Analytics in Supply Chain Management: A Systematic Literature Review and Research Directions." *Big Data and Cognitive Computing* 6 (1): 17. <https://doi.org/10.3390/bdcc6010017>.
- Li, Yuxi. 2017. "Deep Reinforcement Learning: An Overview." arXiv preprint arXiv:1701.07274.
- Melesse, Tsega Y., Matteo Bollo, Valentina Di Pasquale, Francesco Centro, and Stefano Riemma. 2022. "Machine Learning-Based Digital Twin for Monitoring Fruit Quality Evolution." *Procedia Computer Science* 200: 13–20. <https://doi.org/10.1016/j.procs.2022.01.200>.
- Miller, Tim. 2019. "Explanation in Artificial Intelligence: Insights From the Social Sciences." *Artificial Intelligence* 267: 1–38. <https://doi.org/10.1016/j.artint.2018.07.007>.
- Miller, John A., Michael E. Cotterell, and Stephen J. Buckley. 2013. "Supporting A Modeling Continuum in Scalation: From Predictive Analytics to Simulation Modeling." In *2013 Winter Simulations Conference (WSC), Washington D.C., USA, 1191–1202*. IEEE.
- Molnar, Christoph. 2023. *Interpretable Machine Learning*. Morrisville, North Carolina, United States: Lulu.com.
- Montreuil, Benoit. 2017. "Sustainability and Competitiveness: Is the Physical Internet A Solution?" In *4th International Physical Internet Conference (IPIC), Graz, Austria*.
- Nguyen, H. Du, Kim Phuc Tran, Sébastien Thomassey, and Moez Hamad. 2021. "Forecasting and Anomaly Detection Approaches Using LSTM and LSTM Autoencoder Techniques with the Applications in Supply Chain Management." *International Journal of Information Management* 57: 102282. <https://doi.org/10.1016/j.ijinfomgt.2020.102282>.
- Pereira, Marina Meireles, Djonathan Luiz de Oliveira, Pedro Pfeifer Portela Santos, and Enzo Morosini Frazzon. 2018. "Predictive and Adaptive Management Approach for Omni channel Retailing Supply Chains." *IFAC-PapersOnLine* 51 (11): 1707–1713. <https://doi.org/10.1016/j.ifacol.2018.08.210>.
- Pereira, Marina Meireles, and Enzo Morosini Frazzon. 2021. "A Data-Driven Approach to Adaptive Synchronization of Demand and Supply in Omni-Channel Retail Supply Chains." *International Journal of Information Management* 57: 102165. <https://doi.org/10.1016/j.ijinfomgt.2020.102165>.
- Pessot, Elena, Andrea Zangiacomì, and Rosanna Fornasiero. 2024. "Unboxing the Hyper-Connected Supply Chain: A Case Study in the Furniture Industry." *Production Planning & Control* 35 (6): 580–598. <https://doi.org/10.1080/09537287.2022.2110958>.
- Power, Daniel J., and Ciara Heavin. 2017. *Decision Support, Analytics, and Business Intelligence*. New York: Business Expert Press.
- Puskás, Eszter, Ádám Budai, and Gábor Bohács. 2020. "Optimization of A Physical Internet Based Supply Chain Using Reinforcement Learning." *European Transport Research Review* 12 (1): 1–15. <https://doi.org/10.1186/s12544-019-0391-3>.
- Rabia, Mohamed Amine Ben, and Adil Bellabdaoui. 2022. "Simulation-Based Analytics: A Systematic Literature Review." *Simulation Modelling Practice and Theory* 117: 102511. <https://doi.org/10.1016/j.simpat.2022.102511>.
- Ranjan, Jayanthi, and Cyril Foroapon. 2021. "Big Data Analytics in Building the Competitive Intelligence of Organizations." *International Journal of Information Management* 56: 102231. <https://doi.org/10.1016/j.ijinfomgt.2020.102231>.
- Rolf, Benjamin, Ilya Jackson, Marcel Müller, Sebastian Lang, Tobias Reggelin, and Dmitry Ivanov. 2022. "A Review on Reinforcement Learning Algorithms and Applications in Supply Chain Management." *International Journal of Production Research* 61 (20): 7151–7179. <https://doi.org/10.1080/00207543.2022.2140221>.
- Schoenherr, Tobias, and Cheri Speier-Pero. 2015. "Data Science, Predictive Analytics, and Big Data in Supply Chain Management: Current State and Future Potential." *Journal of Business Logistics* 36 (1): 120–132. <https://doi.org/10.1111/jbl.2015.36.issue-1>.
- Souza, Gilvan C. 2014. "Supply Chain Analytics." *Business Horizons* 57 (5): 595–605. <https://doi.org/10.1016/j.bushor.2014.06.004>.
- Suryani, Erma, Shuo-Yan Chou, and Chih-Hsien Chen. 2012. "Dynamic Simulation Model of Air Cargo Demand Forecast and Terminal Capacity Planning." *Simulation Modelling Practice and Theory* 28: 27–41. <https://doi.org/10.1016/j.simpat.2012.05.012>.
- Tirkolaei, Erfan Babaei, Saeid Sadeghi, Farzaneh Mansoori Mooseloo, Hadi Rezaei Vandchali, and Samira Aeni. 2021. "Application of Machine Learning in Supply Chain Management: A Comprehensive Overview of the Main Areas." *Mathematical Problems in Engineering* 2021: 1–14. <https://doi.org/10.1155/2021/1476043>.
- Troise, Ciro, Vincenzo Corvello, Abby Ghobadian, and Nicholas O'Regan. 2022. "How Can SMEs Successfully Navigate VUCA Environment: The Role of Agility in the Digital Transformation Era." *Technological Forecasting and Social Change* 174: 121227. <https://doi.org/10.1016/j.techfore.2021.121227>.
- Valluri, Annapurna, Michael J. North, and Charles M. Macal. 2009. "Reinforcement Learning in Supply Chains." *International Journal of Neural Systems* 19 (05): 331–344. <https://doi.org/10.1142/S0129065709002063>.
- Van Wassenhove, Luk N. 2006. "Humanitarian Aid Logistics: Supply Chain Management in High Gear." *Journal of the Operational Research Society* 57 (5): 475–489. <https://doi.org/10.1057/palgrave.jors.2602125>.
- von Rueden, Laura, Sebastian Mayer, Rafet Sifa, Christian Bauckhage, and Jochen Garcke. 2020. "Combining Machine Learning and Simulation to A Hybrid Modelling

- Approach: Current and Future Directions.” In *Advances in Intelligent Data Analysis XVIII: 18th International Symposium on Intelligent Data Analysis (IDA), Konstanz, Germany*, 548–560. Springer.
- Waller, Matthew A., and Stanley E. Fawcett. 2013. “Data Science, Predictive Analytics, and Big Data: A Revolution That Will Transform Supply Chain Design and Management.” *Journal of Business Logistics* 34 (2): 77–84. <https://doi.org/10.1111/jbl.2013.34.issue-2>.
- Wang, Zhiquan. 2022. “Prediction Method of Coal and Gas Outburst Intensity Based on Digital Twin and Deep Learning.” *Frontiers in Energy Research* 10: 891184. <https://doi.org/10.3389/fenrg.2022.891184>.
- Zaytsev, Alex. 2023, August. “Case Study: AI-Powered Logistics at FedEx.” Accessed January 10, 2024. <https://aiexpert.net/work/case-study-ai-powered-logistics-at-fedex/>.
- Zhang, Tianyuan, Manon Grest, Souad Rabah, Grégory Zacharewicz, Frederick Benaben, and Matthieu Luras. 2023, January. “Simulation-Based Assessment of Hyperconnected Humanitarian Supply Chains Response Readiness.” In *56th Hawaii International Conference on System Sciences (HICSS), Hawaii, United States*, 449–458. HICSS.