



HAL
open science

An Agent-Based Simulation Platform for a Safe Election: From Design to Simulation

Ali Barenji, Benoit Montreuil, Sevda Babalou, Dima Nazzal, Frederick Benaben, Richard Demillo

► **To cite this version:**

Ali Barenji, Benoit Montreuil, Sevda Babalou, Dima Nazzal, Frederick Benaben, et al.. An Agent-Based Simulation Platform for a Safe Election: From Design to Simulation. *Information*, 2023, 14 (10), pp.529. 10.3390/info14100529 . hal-04224682

HAL Id: hal-04224682

<https://imt-mines-albi.hal.science/hal-04224682v1>

Submitted on 2 Oct 2023

HAL is a multi-disciplinary open access archive for the deposit and dissemination of scientific research documents, whether they are published or not. The documents may come from teaching and research institutions in France or abroad, or from public or private research centers.

L'archive ouverte pluridisciplinaire **HAL**, est destinée au dépôt et à la diffusion de documents scientifiques de niveau recherche, publiés ou non, émanant des établissements d'enseignement et de recherche français ou étrangers, des laboratoires publics ou privés.



Distributed under a Creative Commons Attribution 4.0 International License

Article

An Agent-Based Simulation Platform for a Safe Election: From Design to Simulation

Ali V. Barenji ^{1,2,*} , Benoit Montreuil ^{1,2}, Sevda Babalou ^{1,2}, Dima Nazzal ¹ , Frederick Benaben ^{1,2,3} and Richard DeMillo ⁴ 

¹ School of Industrial and Systems Engineering, Georgia Institute of Technology, Atlanta, GA 30332, USA; zb.babalou@gmail.com (S.B.); dima.nazzal@gatech.edu (D.N.); frederick.benaben@mines-albi.fr (F.B.)

² Physical Internet Center, Supply Chain & Logistics Institute, Atlanta, GA 30332, USA

³ Centre Genie Industriel—IMT Mines Albi, 81000 Grenoble, France

⁴ College of Computing, Georgia Institute of Technology, Atlanta, GA 30332, USA

* Correspondence: abarenji3@gatech.edu

Abstract: Managing the logistics and safety of an election system, from delivering voting machines to the right locations at the right time to ensuring that voting lines remain reasonable in length is a complex problem due to the scarcity of resources, especially human poll workers, and the impact of human behavior and disrupting events on the performance of this critical system. These complexities grew with the need for physical distancing during the COVID-19 pandemic coinciding with multiple key national elections, including the 2020 general presidential election in the USA. In this paper, we propose a digital clone platform leveraging agent-based simulation to model and experiment with resource allocation decisions and voter turnout fluctuations and facilitate “what-if” scenario testing of any election. As a use case, we consider three different concurrent polling location problems, namely, resource allocation, polling layout, and management. The main aim is to reduce voter waiting time and provide visibility of different scenarios for polling and state-level managers. We explain the proposed simulation platform based on Fulton County for the 2020 presidential US election. Fulton County had 238 polling locations in 2020, which provided publicly available voter turnout data. The developed platform realistically models at the county level and at specific locations, suggesting the possible allocation of finite resources among locations in the county and the configuration of each location, accounting for physical, legal, and technical constraints. Multiple realistic scenarios were developed and embedded into the simulation platform to evaluate and verify the different systems. The system performance and key attributes of the election system, such as waiting time, resource utilization, and layout safety, were tested and validated.

Keywords: safe and secure elections; digital clone; agent-based modeling; simulation



Citation: Barenji, A.V.; Montreuil, B.; Babalou, S.; Nazzal, D.; Benaben, F.; DeMillo, R. An Agent-Based Simulation Platform for a Safe Election: From Design to Simulation. *Information* **2023**, *14*, 529. <https://doi.org/10.3390/info14100529>

Academic Editor: Katsuhide Fujita

Received: 8 August 2023

Revised: 23 September 2023

Accepted: 24 September 2023

Published: 28 September 2023



Copyright: © 2023 by the authors. Licensee MDPI, Basel, Switzerland. This article is an open access article distributed under the terms and conditions of the Creative Commons Attribution (CC BY) license (<https://creativecommons.org/licenses/by/4.0/>).

1. Introduction

The length of time that voters wait in line while casting their ballots has been a matter of consternation in electorates across the world. For instance, in the aftermath of the 2004 election in Franklin County (Ohio, USA), officials were concerned about the efficiency of voting at different precincts in the county. Some people waited seven hours to vote, while voters at other precincts had no wait at all [1]. Long queues at polling places are disruptive, disenfranchising, and all too common [2]. Studies show that voters who wait in long lines are less confident their votes are counted as intended and that votes nationwide are counted as intended [3]. Green and Gerber [4] quantify the estimated cost of waiting an average of one hour to vote is approximately USD 500 million. Furthermore, long lines at polls may reflect failures of election administration, notably, a lack of preparedness for unanticipated enthusiasm in electoral contests that result in voters flooding polling locations. Long lines can be one of the causes of depressing turnout and dampening voter satisfaction [5].

Unexpected surges in turnout are often perceived as the main cause of long lines at a polling location, but the story is more complex. Some recent studies find [5–7] that the allocation of resources to polling places is a key contributor to long lines. Layout configuration is another factor that may lead to longer queues at polling places. Since the COVID-19 pandemic, physical distancing has become an additional consideration when designing a polling location as more voters, especially as those with health risks, might feel unsafe or uncomfortable voting in a location that does not safeguard against epidemic spread of airborne and communicable diseases. Other examples such as the lack of indoor space and privacy strongly determine overall dissatisfaction inside the polling location [8]. In this case, [9] investigated COVID-19's impact on older adults' perceptions and behaviors in public spaces, revealing safety concerns, especially indoors, and suggesting improvements.

Therefore, managing the logistics of an election plays a crucial role in reducing long lines and improving voter satisfaction [10,11]. We categorize the logistical and safety challenges of an election as follows.

- **Resource resources.** The number of poll employees and voting resources (e.g., poll pads, ballot marking devices, and scanners) are key drivers of voting queues and velocity. Inadequate allocation results in excessive times, notably associated with uncertainty about time-phased voting demand per precinct, voting availability pattern disparities (e.g., blue vs. white collars and retirees), and overall voting turnout. Furthermore, allocation has to aim for geographic and demographic fairness in terms of home-to-vote time, notably avoiding situations where precincts with more minorities or people known to be partisan of a party experience longer wait times [12]. Results of previous election systems demonstrate that fairness in resource allocation at the county level is an important factor due to the limited number of resources allocated to each state [13]. For example, in Florida during the US 2020 election, certain polling locations had average wait times upwards of 80 min, while neighboring polling locations had waiting times of only 7–10 min. It should also be noted that some locations reported significantly higher voter turnout than other locations. In the state of Georgia's 3 November 2020 election, some voters waited over five hours at Christian City, an assisted-living community south of Atlanta [14]. Other locations averaged less than five minutes. During the June 2020 primaries, about 11% of voting sites in Georgia closed over an hour late, according to an analysis by The Atlanta Journal-Constitution of the elections data [15]. The epicenter of voting problems was Fulton County, where more than three-quarters of polling places closed after 8 p.m. [16]. Figure 1 provides a visual representation of this phenomenon. This emphasizes the importance of rigorously analyzing differences in voter behavior.
- **Polling layout and management.** While the efficient and effective allocation of resources is necessary to minimize waiting time, the finite nature of resources and inevitable variability in voter arrivals or service times will inevitably result in queuing for some voters at various times of the day. Thus, polling managers must decide how to best allocate scarce resources to provide the best overall performance throughout layout constraints. Recently, some researchers found that tools that are based on the science of queuing theory can help election and polling managers understand the various trade-offs involved in allocating resources and make the tough decisions that face them [17]. In addition, researchers indicate that layout and path directionality significantly affect average voter travel distance, with the perimeter layout having a unidirectional path being the most efficient [18]. Also, COVID-19 added extra problems to polling places and caused extra attention to layout configuration [19], queue length, and polling workers [2]. Figure 2 shows a schematic of a polling location considering social distancing, safety, and privacy.

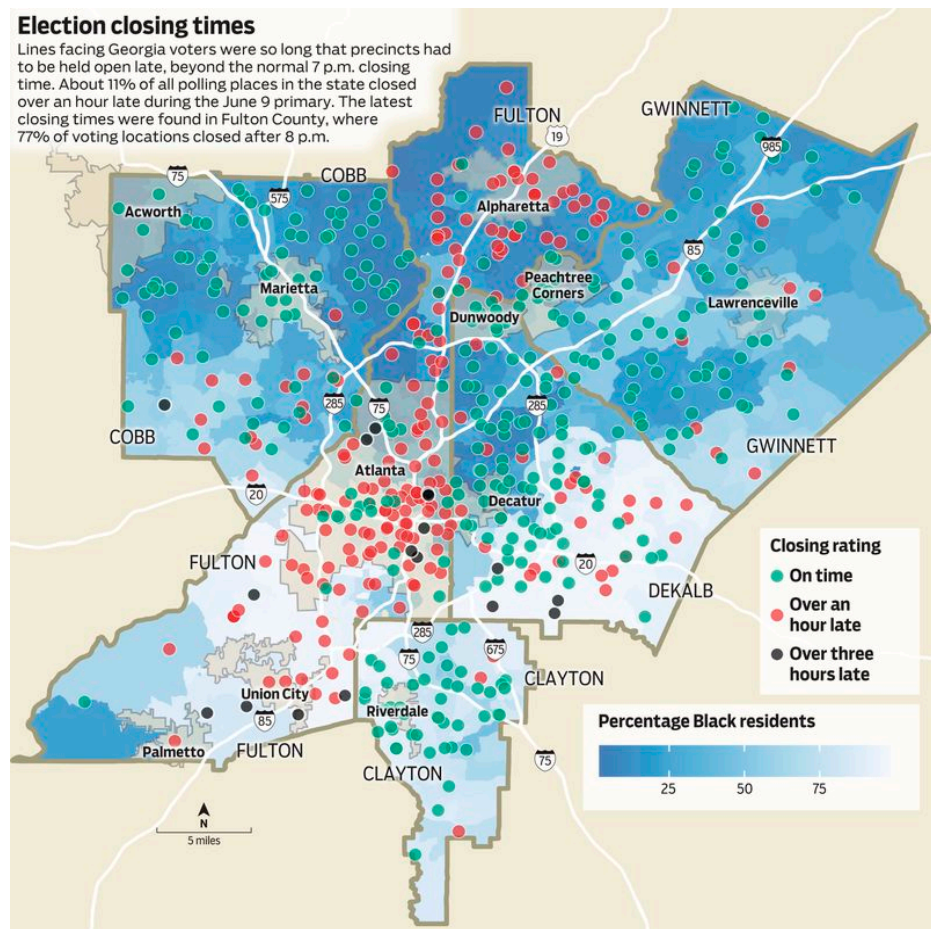

Figure 1. Election data from Georgia on 3 November: 2300 polling places [14].

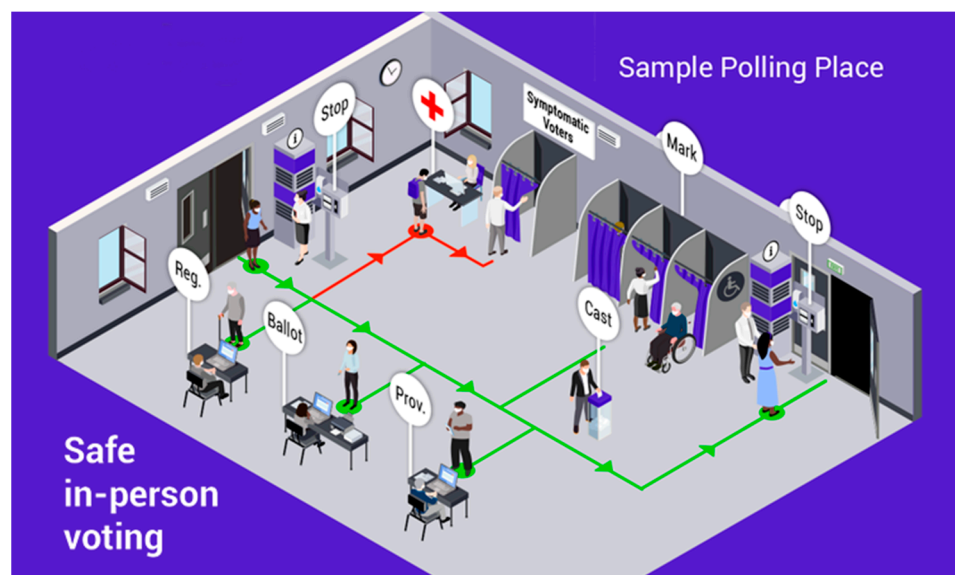

Figure 2. Schematic layout showing the configuration for a polling place [17].

- Every year, millions of Americans travel to their local polling locations to cast their ballots. According to the 2018 Election Administration and Voting Survey (EAVS) report released by the U.S. Election Assistance Commission (EAC), more than 200,000 polling places were opened and staffed by more than 600,000 poll workers in 2018 [20].

Most of the poll workers are part-time, temporary employees hired by local election officials to staff polling places during early voting and on Election Day [21]. Polling places average about eight on-staff workers for the whole day [22]. So, the transport of polling cards, election materials, and devices to polling locations on time is a huge challenge from a logistics perspective [23,24].

Consequently, management of the election system, polling center layout configuration, and resource allocation to polling centers are crucial to reducing waiting times and improving voter satisfaction not only at the polling location but also at the municipal, state, and federal levels. Due to the mentioned problems and some political issues, voter satisfaction with the choice of presidential candidates, already at a two-decade low, has declined even further [25]. Long waiting times to vote were shown to reduce the willingness of voters to vote, where almost 20% of voters lost their willingness to vote for the next election [5,26]. Bernardo et al. [19] studied COVID-19 and the US election system using a simulation platform for a single polling location in Rhode Island. Using the Rhode Island location during the 2020 general election as a case study, the authors demonstrate the application of discrete event simulation for in-person voting to quantify the effect of COVID-19 on the performance of the single polling location. It is worth mentioning that most of the existing work in this respect focused on one polling location and mostly simulated limited scenarios [10,17,26].

To evaluate and solve election problems, we propose an agent-based methodology to develop a simulator that is able to simulate the election process at the county level as well as polling locations. This study aims to reproduce different scenarios and support diverse turnouts, resource allocation, and resource failures.

This paper highlights four main contributions: (1) the methodology for designing and developing an agent-based simulation platform for election systems, (2) the development of a proposed simulation platform that facilitates election-specific functionalities such as resource allocation, the layout configuration of polling locations, and management of election-day operations, (3) the application of diverse realistic scenarios to evaluate and validate the simulation platform, and (4) the identification of insights and recommendations for improving election systems based on the simulation outcomes.

The rest of this paper is organized as follows. Section 2 explains the proposed methodological framework for an agent-based digital clone platform of the election system. Section 3 presents the case study and describes the system's modeling based on the case study. Section 4 explains the simulation benchmark and different what-if scenarios. Section 5 discusses the results obtained from the simulations. Finally, Section 6 concludes this paper and outlines future research directions.

2. The Methodological Framework

The proposed methodological framework is shown in Figure 3 and contains three phases and one column, namely, the system requirement phase, the system design and development phase, the implementation phase, and the verification and validation (V&V) column, which is connected to all phases in order to perform the V&V process in each phase (Figure 3). Each phase is explained as follows.

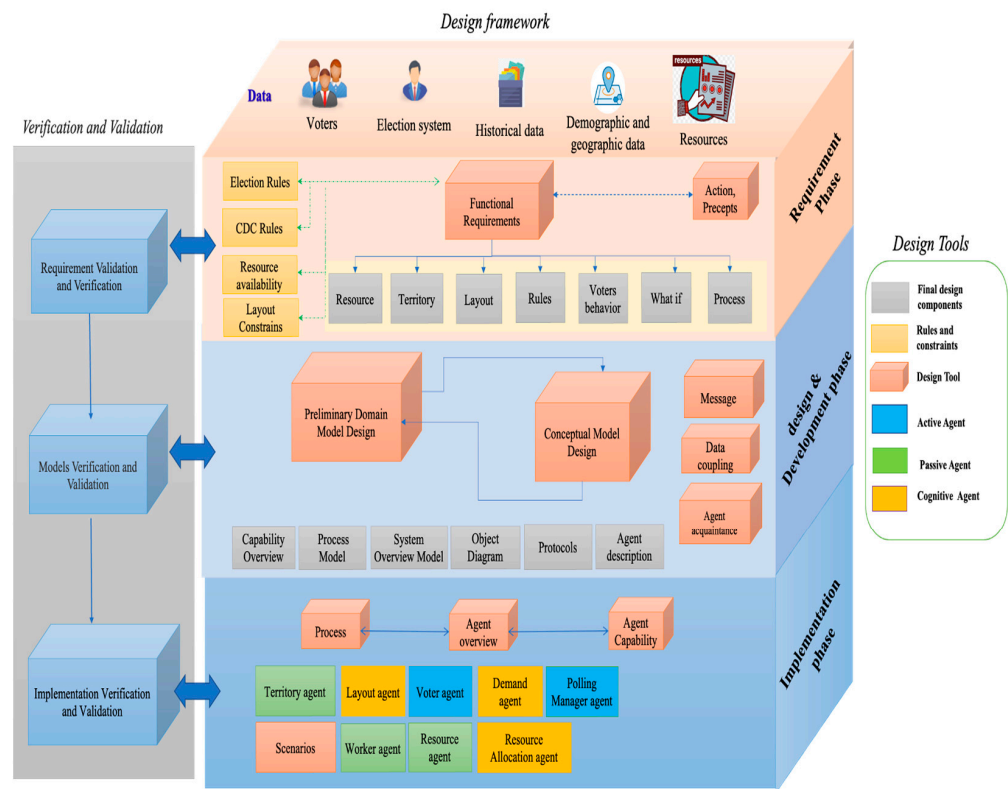

Figure 3. The methodological framework for the simulation platform of an election system.

1. The system requirement phase focuses on mimicking the election specification and captures holistically the difficulties that potentially need to be improved. It identifies the goals, basic functionalities, and requirements of the system along with the inputs such as election rules, CDC rules (Centers for Disease Control), layout constraints, and resource availability, which are extracted from historical and available data. The output of this phase includes territory specification, layout specification, logistic specification, process specification, and system goals. The system requirement defines the players participating in the system, describes the scenarios of participation by defining the initial functionality descriptors, and, finally, identifies the system goals. The following figure (Figure 4) shows the three phases of each election, which are mimics of the existing process. The focus of the proposed platform is pre-election and election.

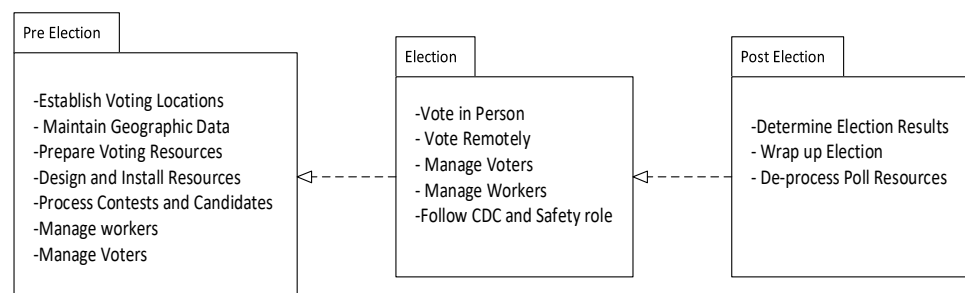

Figure 4. Package diagram of an election.

2. In the design and development phase, we design and model election systems using a multi-agent-based modeling approach. This approach aims to identify and create an election system based on diverse types of agents. In this phase, the election system is considered structurally. The first preliminary domain model is created based on the requirement analysis phase; then, considering the close loop feedback method [27],

we construct the detailed design of the system. The output of this phase includes a capability overview, process model, system overview model, object diagram, and agent-based description diagram. Each of these models is explained as follows.

- Capability overview: A capability overview diagram is a visual representation of the key functionalities and goals of a system.
 - Process model: A process model is a formal representation of a process, which is a set of activities that transform inputs into outputs.
 - System overview model: A system overview model defines a set of functionalities linked to one or more capabilities and captures a piece of the system behavior.
 - Object diagram: An object diagram represents the static view of a system, but this static view is a snapshot of the system at a particular moment. Object diagrams are used to render a set of objects and their relationships as an instance.
 - Agent description model: An agent description model defines and integrates a set of capabilities and decisions for each agent.
3. In the implementation phase, the proposed agent-based model is implemented using defined agents and protocols. An agent discrete event-based approach is used for this implementation. Each agent and its responsibility are implemented based on the design and development phase. Different scenarios such as machine disturbances and high demand turnout are implemented in the platform during this stage.
 4. The V&V column is responsible for validating and verifying each phase before information moves to the next step. There are three steps of V&V in this framework. Requirement V&V uses the satisfy and verify dependencies approach to validate the functional requirements [28]. V&V models are responsible for validating and verifying the domain model and conceptual model [29]. The last V&V is implementation V&V, which verifies the implementation of the design system using the QA approach.

The proposed methodological framework is explained using 2020 election data from 238 polling locations in Fulton County, Georgia, USA. The case study is explained in detail as follows.

3. Case Study Description

Fulton County is located in the north-central portion of the U.S. state of Georgia. According to 2019 estimates, the population is 1,063,937, making it the state's most populous county and the only one with over 1 million inhabitants. According to the U.S. Census Bureau, the county has a total area of 534 square miles (1380 km²), of which 527 square miles (1360 km²) is land and 7.7 square miles (20 km²) (1.4%) is water. The county is located in the Piedmont region of the state in the foothills of the Blue Ridge Mountains to the north. Fulton County contains 15 cities, including Georgia's capital city, Atlanta. Figure 5 illustrates these cities [30]. A total of 238 polling locations were defined in Fulton County, and Figure 5 shows the location of these polling on a map. The median age is 35.7, 66 percent of the population is between 18 and 64, and 12 percent of the population is over 65. Around 52 percent of the population is female.

The ballot system in the United States is a way for eligible citizens to cast votes in elections for their chosen leaders who will make important decisions. Following is a simple explanation of how it works.

Voter registration is required before a person can vote. Age, citizenship, and residence are used to verify their eligibility. States have different registration requirements. On election day, registered voters go to their assigned polling locations, which are often schools, libraries, churches, or government buildings. There are two types of ballots: paper ballots and electronic voting machines. In our case, all the polling locations have electric voting machines. The other key consideration is the privacy of voters. Voting is typically performed in private to protect a voter's choices. This means no one should know how a person voted unless they choose to share it. After the polls close, election officials count the votes. This process may take some time, especially in larger elections. Then, the winning candidates are declared.

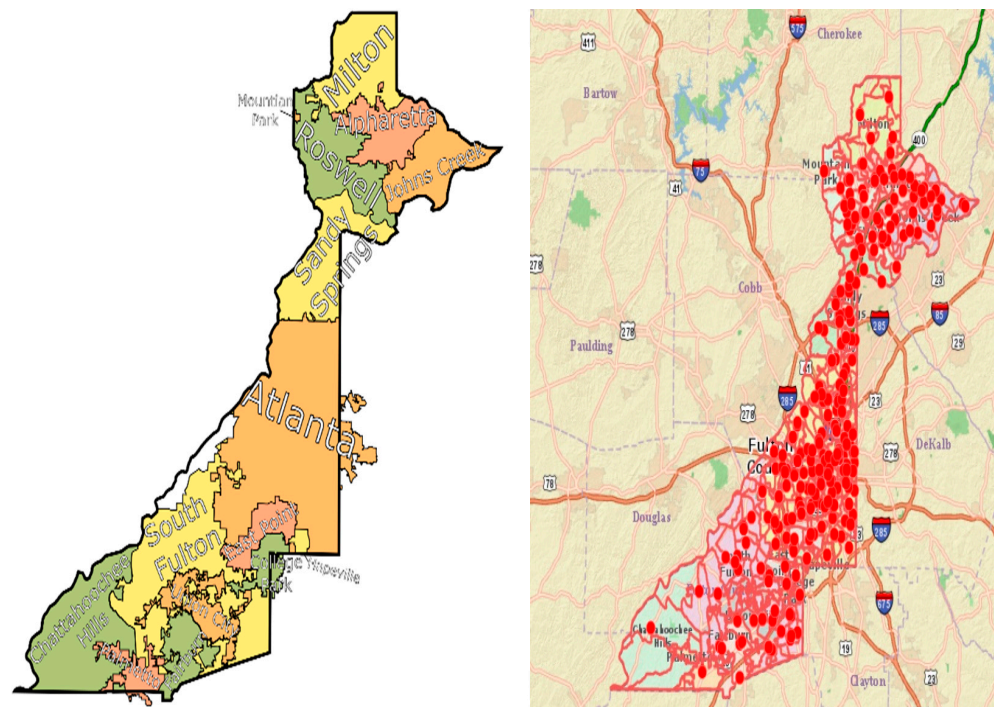

Figure 5. Geographical information for Fulton County and 238 locations of the polling centers.

3.1. Requirement Phase of the Case Study

The requirement phase defines the functionality of an election system and polling locations. It helps identify missing needs, which helps clearly define the expected system services and behaviors. The input for the requirement phase includes historical data, rules, and existing constraints. The requirement phase contains two design components, namely, the initial function Description (IFD) and action and precepts (A&P). The IFD uses a functional requirement analysis approach to describe the election system and its subsystem. It consists of four main functions, namely, a resource specification function (RSF), a process requirement function (PRF), a regulatory requirement function (RRF), and a territory specification function (TSF). Figure 6 shows a requirement diagram and its sub-classifications.

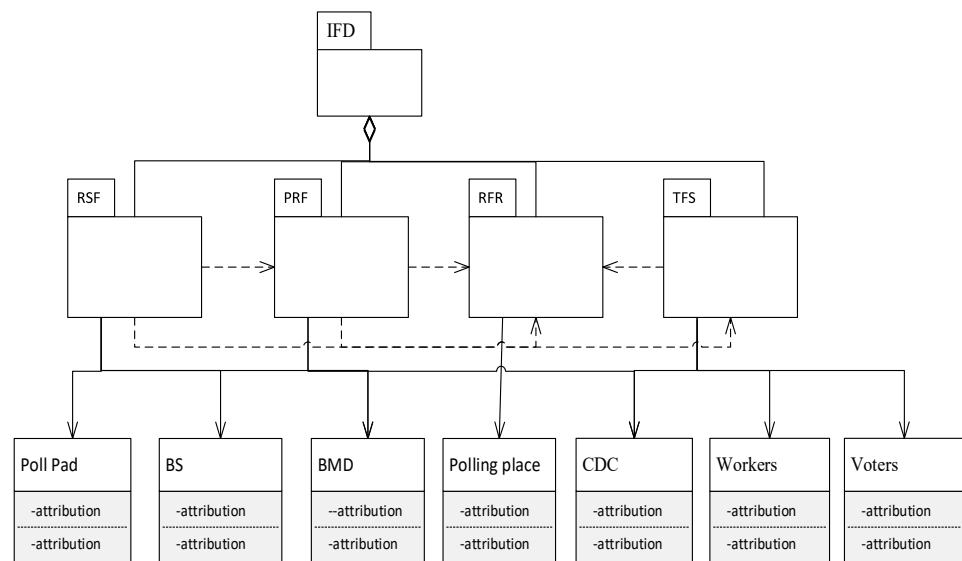

Figure 6. A requirement diagram and its sub-classifications.

- Resource specification function: The RSF helps us define the functionality of the resources and machines that need to be considered and used in the election system. The main resources of the 2020 election are defined as follows.
 1. Poll pads (PPs) are used in place of paper poll books to check in voters, determine whether they have already received or voted using a mail ballot, and direct them to their correct polling location if they are in the wrong location.
 2. Ballot marking devices (BMDs) are computerized devices that display a digital ballot, allow voters to make selections, and then print paper records of the voters' choices. BMDs can be enabled with accessible user interfaces, providing essential assistive technology for voters who may be uncomfortable or incapable of marking a paper ballot by hand. With a BMD, the voter uses a touchscreen to choose candidates; then, the device prints out a ballot summary card that the voter can examine for accuracy before depositing it in a ballot box or into a ballot scanner. In some system configurations, "auto-cast" can be enabled, and voters are not given the option to verify the printed ballot. Instead, the ballot summary card is cast, scanned, tabulated, and dropped in the ballot container at the backside of the machine without voter review.
 3. A ballot scanner (BS) is a compact electronic voting system that utilizes an optical scanner to read significant paper ballots and tally the results. This system permits paper ballots to be immediately tabulated at polling locations.
- Process requirement function: The PRF helps us understand and define the functionality of the different levels in the system, such as workers, managers, voters, and the process functionality of resources. We divided the PRF into three sub-functions: the voting process, the managing process, and the resource process.
 1. The voting process is a process model of the polling location and shows the flow of the voting process. Figure 7 shows an object diagram of the voting process.
 2. The managing process is divided into two sub-managing sections. The first is during the pre-election and election day related to layout configuration and workers. The second sub-section manages the location before and after the election by following the rules and regulations.
 3. The resource process is a requirement that is related to receiving, sending, configuring, and maintaining resources in the polling locations.

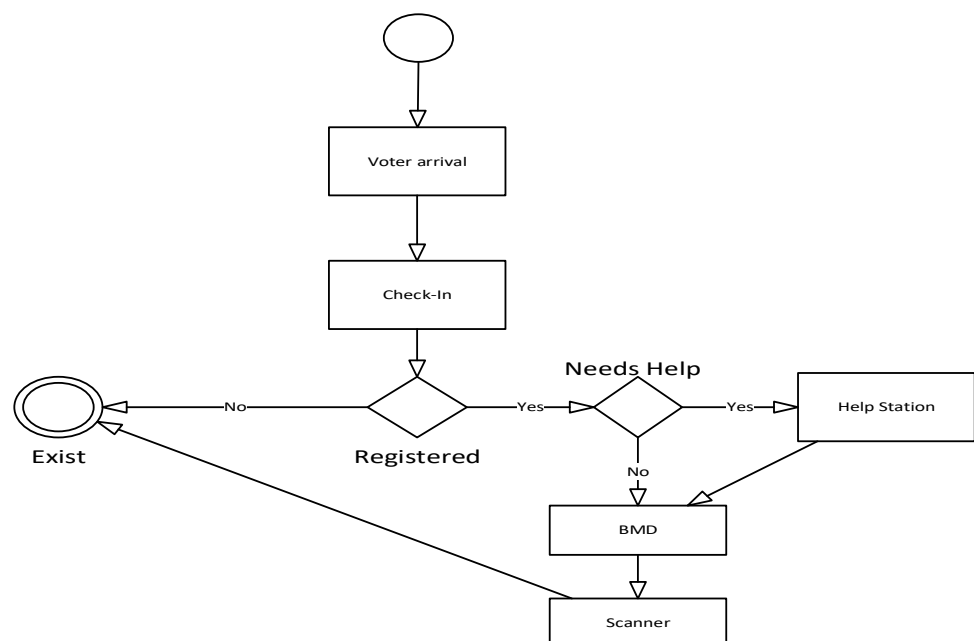

Figure 7. An object diagram showing the voting process.

- Regulatory requirement function: The RRF helps us make written rules, such as election rules (e.g., security), and CDC rules understandable and easy to follow for implementation into the system. These rules include COVID-19 safety at the poll's location, social distancing, voter check-in and qualification process, election worker health and safety, and security of voting resources.
- Territory specification function (TSF): The TSF helps us find the polling location geographic data and define the main limitation and constraint for each location. There are two types of polling places. The first is public buildings, which could be located inside a building, and that building should be a public building. The second is private buildings. If a suitable public building is unavailable for use, the polling place may be located in another building, including churches, clubhouses, private community centers, and grocery stores. This function helps us identify the main constraints of the location in terms of layout configuration, social distancing, cleaning, and sanitizing the polling place

3.2. Design and Development Phase

The system and subsystem functionality of the election system are captured and defined in the requirement phase. The functionalities are the main input to the design and development phase. A crucial step in the design or redesign of a system is to provide an abstract level of representation of the system's resources, activities, and decisions [31]. To achieve this aim, we used a structural modeling approach [27,32]. The purpose of the structural modeling approach is to produce a conceptual schema of agents and their relationships in order to (1) facilitate the process of communication among the agents, (2) establish a common model that can accommodate the different needs of resources, workers, voters, and polling locations, and (3) create a logical model that can be implemented in the simulation platform. In practice, two methods of structural modeling dominate: the procedural approach and the object-oriented approach. Both methods cover the same aspects of a system (e.g., processes, activities, and objects), and may use a variety of existing tools such as IDEF0, data-flow diagrams (DFD), and unified modeling language (UML).

We designed and modeled the election system using an object-oriented structural modeling method based on UML as a modeling tool. UML is a general-purpose, developmental, modeling language in the field of software engineering that is intended to provide a standard way to visualize the design of a system and supports the specification, analysis, design, verification, and validation of diverse systems.

3.2.1. Preliminary Design

A system overview diagram is an applicable diagram that shows connections among workers, voters, and resources of an election system. Figure 8 shows schematically how voters and workers register and interact within the election system. The upper subsystem (registration) contains three use cases for voters and workers: register, update, and re-register. The link between this subsystem and the voter or worker indicates that the operator is charged with updating or registering the address or living locations, which could be effective for assigning polling locations for the voter or worker. The polling location subsystem has seven use cases. These use cases are directly or indirectly related to polling location subsystems, which act as preliminary operations to create and maintain the subsystems.

To better understand the overall election process and subsystems in this complex system, Figure 9 shows a capability overview diagram. It provided a static view of the capabilities of the election system and its main subsystem classes. The top section of this diagram divides the election system into three main classes: pre-election, election, and post-election. The election management class plays an orchestration role between these three classes, and it contains polling locations, resources, rules, applications, and operations and process classes.

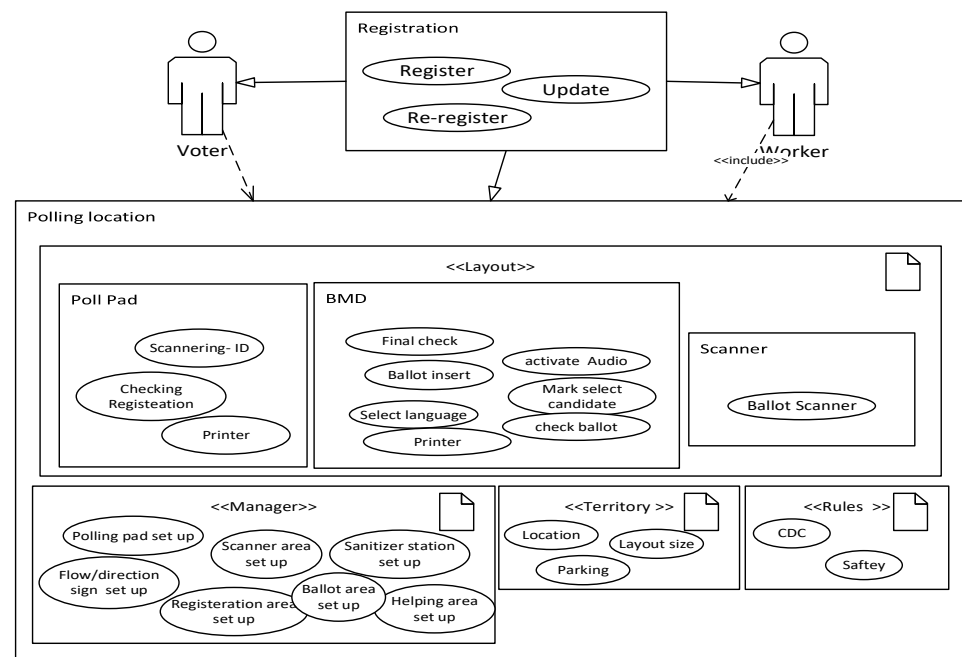

Figure 8. System overview model for a polling location.

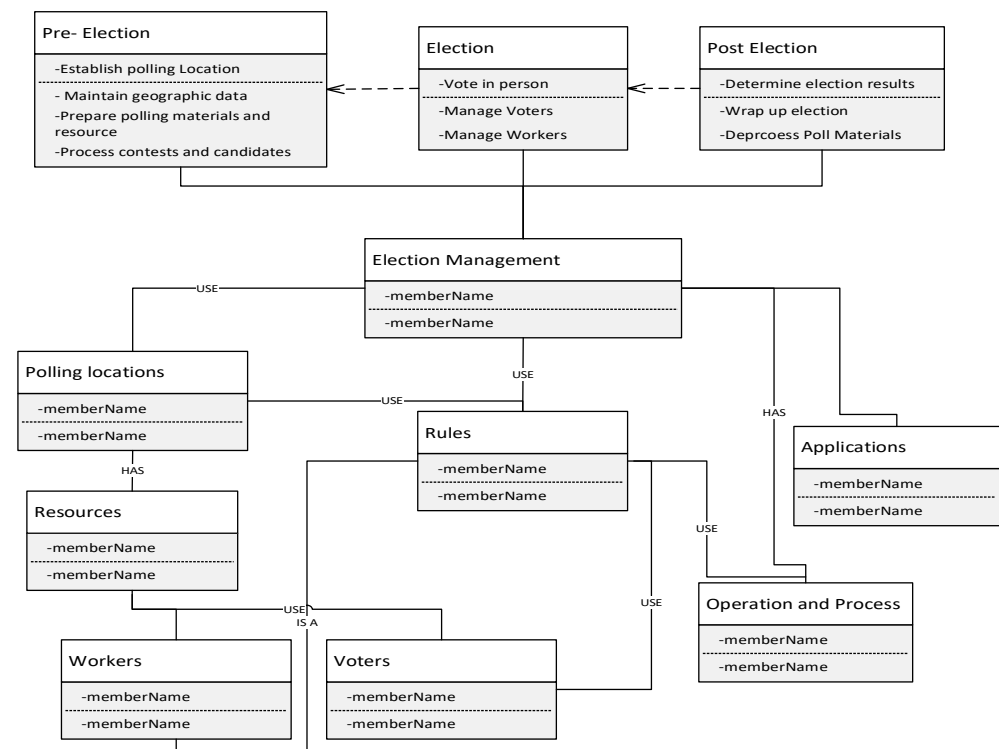

Figure 9. Capability overview diagram of the election system.

To better understand the operation of polling locations, a process diagram was created, which highlights the selection and preparation process model of the polling locations (see Figure 10). The selection process starts by considering the accessibility and usability of the location. Throughout this policy, the full potential of polling locations within the county was considered.

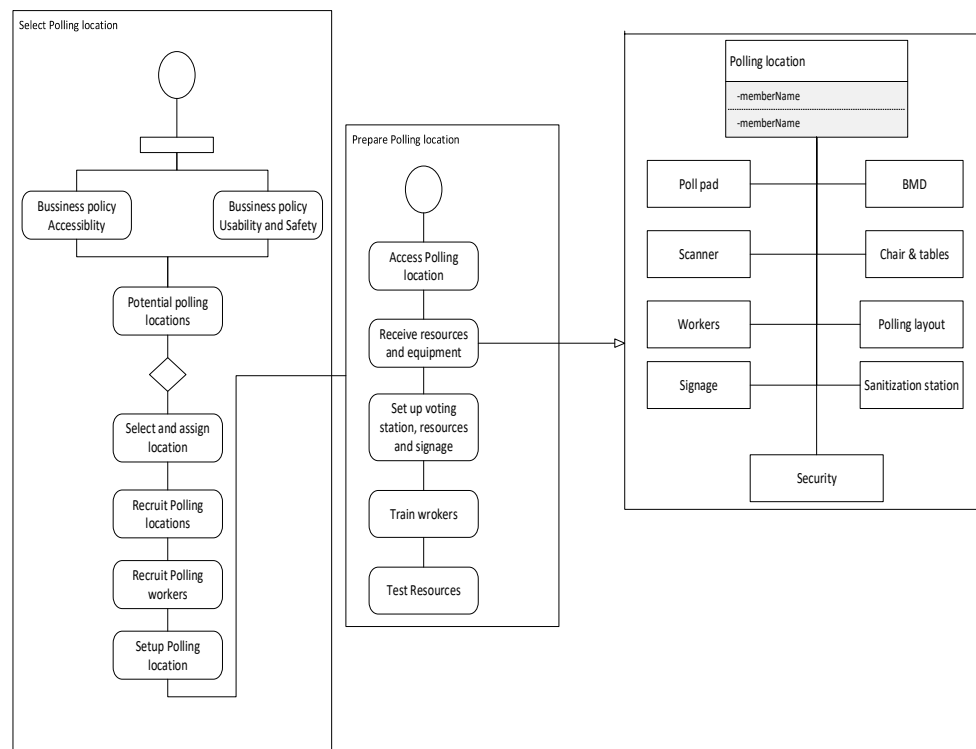

Figure 10. Process model: object and flow diagram showing the selection and preparation of a polling location.

Figure 11 shows a process diagram of a polling location. This process diagram is based on the polling location layout and CDC rules divided into two main sections. The first section is called the outside queue, which serves as the initial waiting location in case the polling location’s capacity is full. The sequence diagram associated with the outside queue is also shown in Figure 11. To ensure social distancing and minimize the risk of disease transmission, the CDC guidelines have been followed, and a safe distance has been maintained between people. The second section is referred to as an inside queue, which is the main area that we focus on to evaluate the proposed modular layout. To calculate the maximum capacity of the location, we applied queuing theory based on the existing works by [3,17]. Figure 12 shows the process for calculating the maximum capacity of the polling location with an example.

To effectively describe the agents in the proposed design, we utilize sequence diagrams to highlight their interactions. A sequence diagram provides a high-level overview of the static communication between the agents in the design, which is depicted in Figure 13. This figure effectively illustrates the eight different agents present in the design. The process begins with the demand agent, which receives geographical data from the territory agent and computes the demand data for each location. This information is then forwarded to the resource allocation agent, which utilizes advanced algorithms to compute the number of resources required for each location and subsequently transmits this information back to the territory agent. The territory agent then assigns these data to the layout agent, which uses geographical data and data from the other agents to create the layout configuration and locate resources. Once this process is complete, the layout agent sends the information to the resource and polling manager agents, which are responsible for evaluating the layout and performing their respective duties if the layout is deemed acceptable. Upon acceptance of the received information, the polling manager agent sends the data to the worker agent to create workers in the location with their respective responsibilities. Lastly, the voter agent is created, and specifications are added to this agent. A detailed explanation of each agent is provided in the subsequent section.

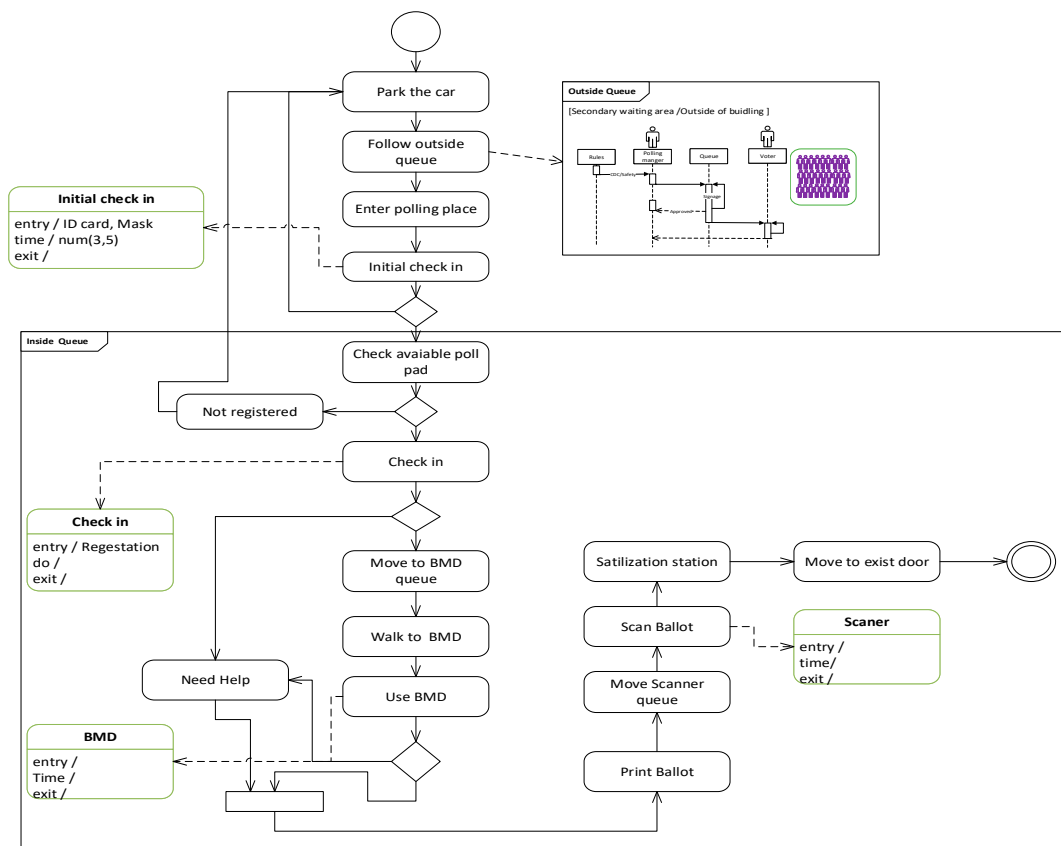

Figure 11. Process diagram of a polling location.

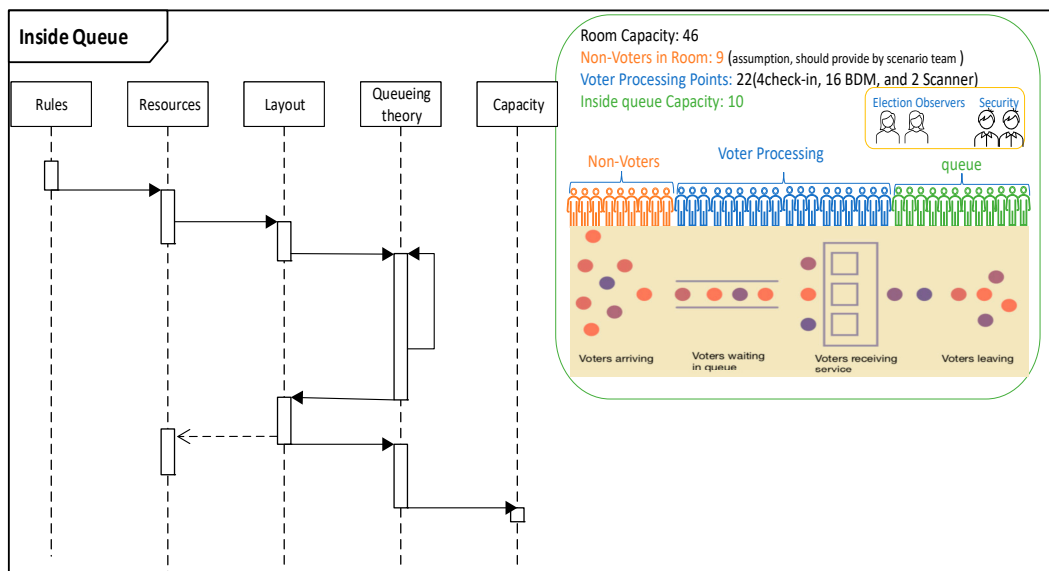

Figure 12. Inside queue and queuing theory for computing maximum capacity.

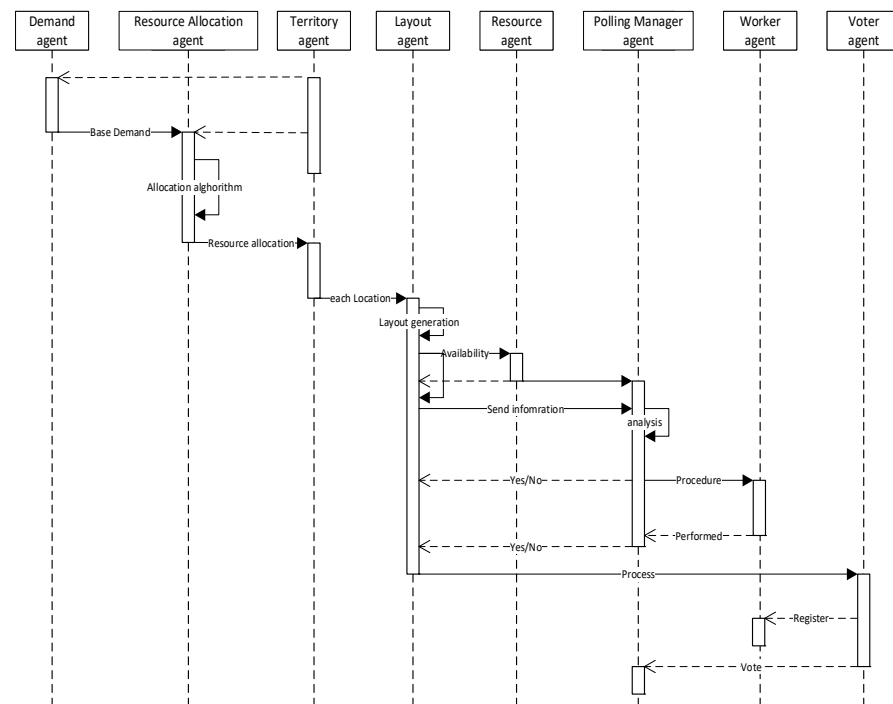

Figure 13. Sequence diagram and negotiation process of agents.

3.2.2. Detail Design

This section explains the detailed design of each agent. In the proposed design, there are three types of agents. These three types of agents are passive agents, active agents, and cognitive agents. A passive agent (PA) is an agent that simply waits for a message or event to perform a job and does not initiate any specific decision or communication on its own. An active agent (ACA) is an agent that can initiate actions or decisions on its own and participate actively in the communication process. A cognitive agent (COA) is an intelligent agent that can perceive, learn, communicate, and make decisions or modify decisions based on new information. Table 1 explains each agent in detail.

Table 1. Agent overview and description.

Name	Type	Responsibility	Input	Output
Demand agent	COA	Demand planner for each polling location	Historical, demographical, and current voting rules data	Resource allocation agent and territory agent
Resource allocation agent	COA	Resource allocation for each location	Demand data and rules (e.g., maximum waiting time is 30 min)	Territory agent
Territory agent	PA	Geographical information and layout information of polling location	Demand agent, resource allocation agent, and historical data	Layout agent, demand agent, and resource allocation agent
Layout agent	COA	Layout configuration, 3D layout, resource, and geographical data for each location	Territory agent	Polling manager agent, resource agent, worker agent, and voter agent
Resource agent	PA	Process time for each resource	Historical assessment	Polling manager agent
Polling manager agent	ACA	Managing polling locations in a dynamic fashion	Resource agent and layout agent	layout agent, resource agent, and worker
Worker agent	PA	Help for voters such as check-in, help	Polling manager agent	Voter agent and resource agent
Voter agent	ACA	Perform voting operation	Resource agent and worker agent	Worker agent, resource agent, and polling manager agent

To generate demand for each location, the demand agent used historical election data, demographic data, and geographic data. Figure 14 shows the structure of the demand agent and highlights the possible results including daily demand for each location, weekly demand, and demographic demand. Of course, the prediction of the demand for each location is not the main scope of this research; therefore, to fulfill different possible demands in the proposed simulation platform, the demand agent lives out of the simulator in a different environment. Therefore, it is possible to input and simulate different demand prediction algorithms in the future.

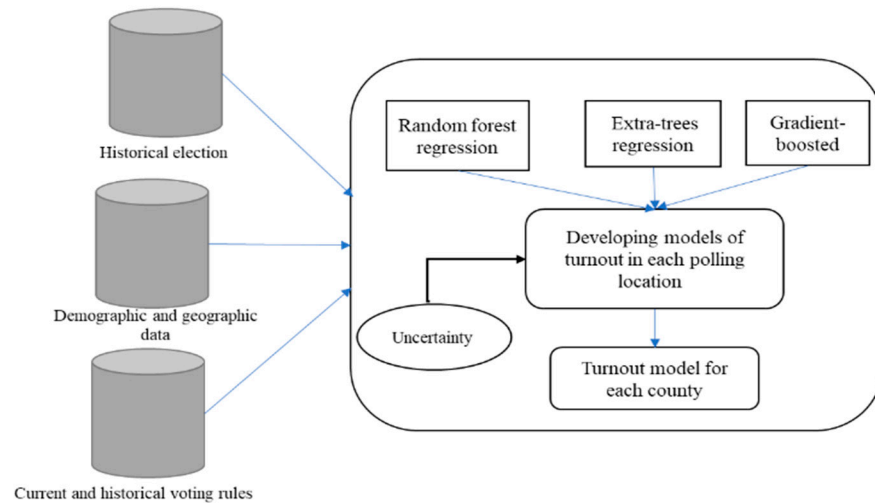

Figure 14. Demand agent structure.

The layout agent is responsible for generating the layout for each location based on modularity logic. This agent is explained in Figure 15. The layout agent leverages a grid-based layout approach [33] to encapsulate queues, workers, voters, and machines using logic. Adaptability, agility, efficiency, privacy, and safety form the main logic of this agent. Each of them is defined as follows.

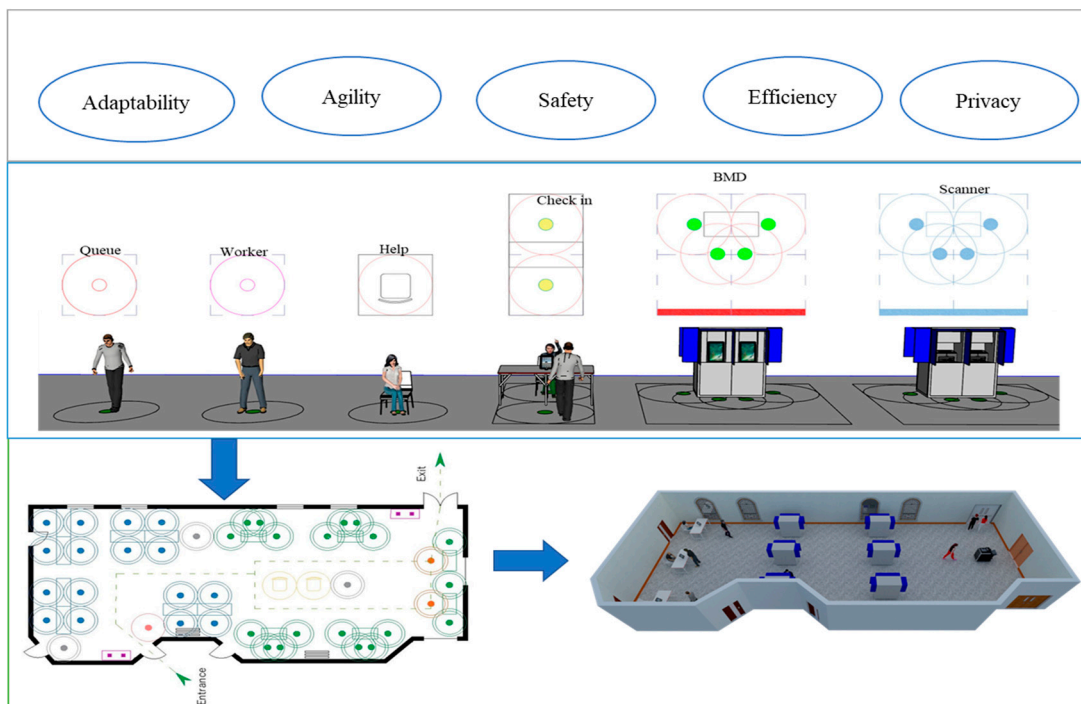

Figure 15. The main logic of the layout agent.

- **Adaptability:** The layout needs to be adaptable to different polling locations with a different number of resources.
- **Agility:** The layout needs to be agile to add or remove resources in the polling location.
- **Safety:** The layout must follow the CDC’s social distancing rules to improve the safety of voters and workers.
- **Privacy:** The layout needs to provide protection for voters in terms of secret ballots.
- **Efficiency:** The layout needs to be easy to use and have a fast and efficient flow, with fewer interactions between voters.

The resource allocation agent is responsible for allocating resources to each location. Because there are limited resources at each county, this agent should follow the rule of a maximum 30-min waiting time at each location by considering the demand and process time to allocate resources to all locations. The logic of this agent follows the existing work in this domain using the indifference zone generalized binary search (IZGBS) method, which is defined as follows [34];

- The method rigorously guarantees that all voters can expect to wait a prescribed time with a bounded probability, e.g., everyone expects to wait less than thirty minutes with a probability greater than 95%.
- The method can handle both a single type of resource (e.g., voting machines or scan machines) and multiple resource types (e.g., voting machines and poll books).

The agent is designed to address the challenge of resource allocation at polling locations. The process begins by providing basic information about the election, such as the date, location, data on the time it takes voters to cast their ballots, the expected number of voters, and their expected arrival times. Two possible approaches are provided for estimating waiting times: apportionment and allocation. In the case of apportionment, the user is prompted to specify a waiting time threshold. The agent then uses the IZGBS algorithm to estimate the waiting time for each voter based on their expected arrival time and the total waiting time of previous voters. If the waiting time exceeds the threshold, the voter’s ballot is rejected. Otherwise, their ballot is accepted, and the total waiting time is incremented accordingly.

In the case of allocation, the agent is prompted to specify the number of runs and then uses an iterative version of the IZGBS algorithm to estimate the waiting time for each voter for each run. After all runs are completed, the resource allocation agent calculates the average waiting time for all runs. To have high flexibility and provide better possibilities to change resource allocation methods in the future, this agent, similar to a demand agent, is located outside of the simulator in a different environment.

The resource agents are passive-type agents that represent resources such as BMDs, poll pads, and scanners in the system. When the voter agent moves in front of these agents, based on the requested services by the voter agent, they provide service for them. In our case, we consider the following service time for resource agents, which are computed from historical data. Table 2 defines service time and recovery delay for each resource.

Table 2. Service time of resource agents.

Resource Agent Name	Service Time	Recovery Delay
Primary checking	Uniform (5, 25) s	0
Poll pad	Normal (4, 0.5 ²) m	Uniform (5, 10) s
BMDs	Normal (8, 22) m	Uniform (1, 5) s
Scanners	Uniform (15, 45) s	Uniform (1, 5) s

Voter agents are active agents that represent the voter. In the platform, we considered different races, educational levels, ages, and poverty using the following sources. Also, we assumed that 3 percent of the population needed help to perform election [35,36].

Polling manager agents are active in this platform and represent the manager in each polling location, these agents are responsible for managing the location and workers, such as queue length, monitoring the process, and people in and outside of polling.

The territory agent is a passive agent that is responsible for providing geographic information as well as visualization of the information on the GIS map.

4. Implementation Phase and Scenarios

The proposed agent-based system was implemented using a discrete-event agent-based simulation platform. JAVA programming language was used to implement the framework, and a MySQL database was used for storing the information. Python was used to implement the demand agent and resource allocation agent outside of the simulator, and the real-time connection between these two environments was created using the Pyplene library (python connector library for Anylogic). A message-based approach was used to create a negotiation process between agents. Figure 16 shows the implementation and development environment.

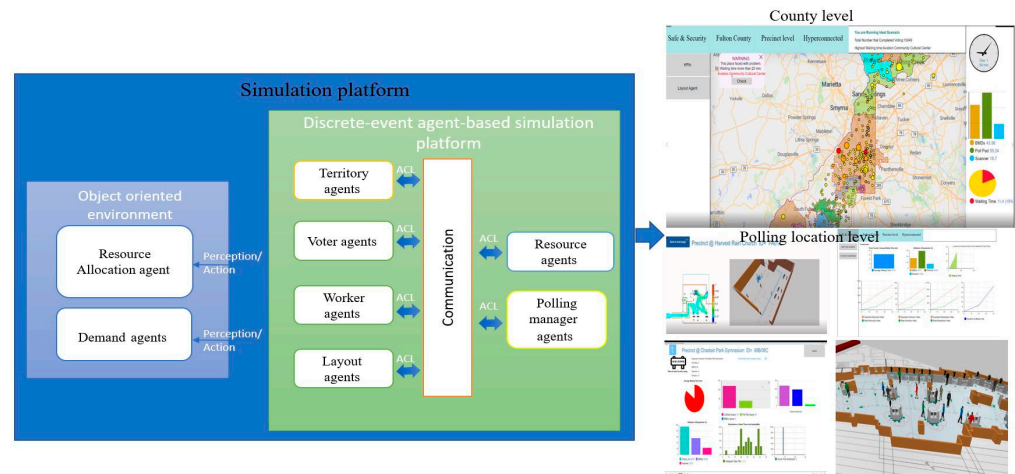

Figure 16. Developed simulation platform.

Scenarios

In this section, we discuss three possible scenarios that were projected for evaluating the platform. The first scenario was related to the demand agent. We considered two sub-scenarios for 3 November 2020 (election day): high election day turnout and more probable election day turnout.

The high turnout scenario (HT) assumed that 85% of registered voters in Fulton County would vote on election day. We made this assumption based on the record-high turnout of 74% in the 2008 General Election in Fulton County, along with an increased enthusiasm factor of 11%. For this case, the mean absolute percentage error (MAPE) is 9%, which is acceptable.

The more probable turnout scenario (MPT) assumed that 60% of registered voters across all polling locations would vote on election day. This turnout rate was based on the 2016 General Election turnout per polling location, with a 5% increase in voter enthusiasm. The MAPE value is equal to 10%, which is almost near to the HT scenario.

The disruption scenario was categorized into two main categories: resource failures and worker issues. The first category, resource failures, focused on the potential issues that could arise with BMDs and IT system failure during the voting process. The first BMD failures included a single machine breakdown for one hour during the peak demand time. The IT system failure was considered an entire IT system failure (ITF) for one hour, considering all machines were down for that time.

The second category, worker issues, considered possible disruptions surrounding poll workers, who are essential to the in-person voting process, especially during the COVID-19

pandemic. Two scenarios were created for this category. The first scenario involved a single poll worker who does not show up the entire day (absent), which could make the check-in process much slower and lead to longer wait times for voters. The second scenario involved a delay in the opening of the polling location by one hour, which would result in voters waiting outside and a queue forming due to the lack of flow through the system during that time.

It is important to note that these scenarios are hypothetical, and the actual disruption scenarios may vary. However, this study aimed to provide a realistic analysis of the potential impacts of these disruptions on the voting process. By simulating these scenarios, this study can identify potential vulnerabilities in the system and develop appropriate mitigation strategies to minimize their impact.

5. Results and Discussion

In this study, the results section is divided into two parts. The first part focuses on the county-level KPIs and evaluates the system at high levels. Table 3 lists the KPIs for all scenarios in detail. In Figure 17, each polling location is represented by a circle on the map. The size of the circle indicates the queues (both outside and inside), the color of the circle shows the average waiting time at the polling location (white < 1, 1 < green < 10, 10 < yellow < 20, 20 < orange < 25, red > 25), and the center of the circle represents the geographical location of the polling station. By clicking on each circle, the simulator directs the user to the specific polling location, illustrates the specific KPIs of the location, and generates a 3D layout.

Table 3. Result of the simulation for different scenarios.

	Demand		Disruptions (More Probable Turnout)			
	MPTs	HTs	Resources		Workers	
			BMD Failure	eITF	Absent	Delay of Opening
BMD utilization	69.18%	91.25%	66.5%	61.01%	68.8	62.5%
Poll pad utilization	87.14%	95.41%	86.11%	78.5%	82.1	79.5%
Scanner utilization	32.4%	44.78	32.1%	25.1%	32.2	26.4%
Average waiting time	14.88	23.14	16.09	26.1	16.5	24.1
Average queue in polling locations	4	9	6	8	4	7
Average queue outside of polling locations	10	21	12	28	11	22

This study found that the best performance in terms of resource utilization occurs in the high-demand scenario, where poll pad utilization is 95.41%, BMD utilization is 91.25%, and scanner utilization is 44.78%. However, due to high turnout, some locations faced long queues. Figure 17 shows that around 78 locations had waiting times between 30 and 40 min, which directly affected the average waiting time (44.78 min). The average total queue (outside + inside) was 30 people. The results of the MPT scenario showed that all polling locations could satisfy the maximum waiting time, which was less than 30 min. BMD utilization was 61.18%, poll pad utilization was 87.14%, and scanner utilization was 32.4%. It is clear that in both demand scenarios, poll pad utilization was higher than BMDs and scanners. The average total queue was 14, and the most frequent waiting time was between 20 and 24 min.

The study also examined disruption scenarios by considering the most probable turnout scenario. BMD failure had a major effect on BMD utilization, reducing the value to 66.5%, but had a minor effect on the poll pad and scanner utilization. BMD failure increased the average total queue to 18 people and the average waiting time to 16.09 min. However, all polling locations could still satisfy the maximum waiting time. The eITF had a major effect on all resource utilizations and the average waiting time because it occurred

during the busiest time of the day. This problem increased the average total queue to 36 people, and for small locations, it caused major issues in terms of people waiting outside the polling location.

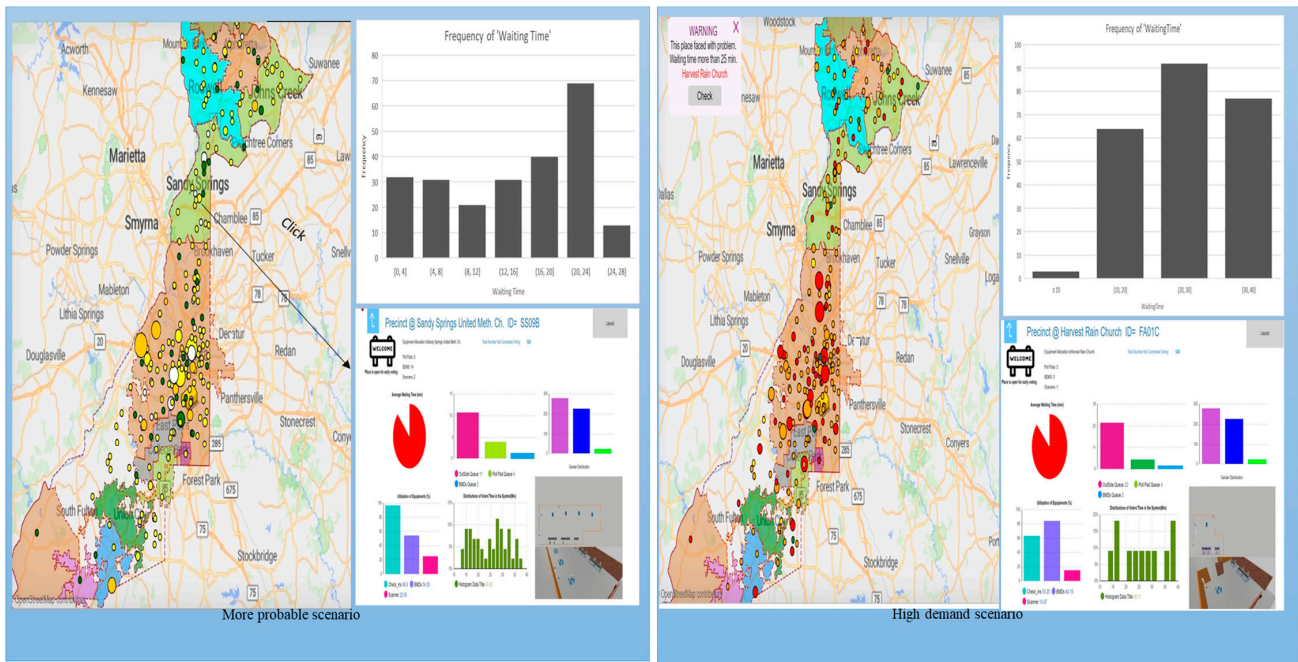

Figure 17. Snapshot of KPIs visualization in the simulator.

The absent scenario, where workers did not show up all day, had a greater effect on poll pad utilization and a minor effect on BMDs and scanners, as it increased the average outside queue at the county level. However, it is worth noting that this scenario did not apply to single-poll pad locations. Finally, the one-hour delay in opening polling locations had a major effect on resource utilization and queues. Still, its effect was less than that of eITF because it occurred early in the day when demand was low.

In the second phase of our evaluation, we focused on the layouts generated using the simulator for each polling location. To evaluate the proposed layouts, we used the layout safety (LS) indicator, which measures the possibility of voter interaction. The LS indicator was visualized using a heat map for each location. The results of the layout safety evaluation are presented in Figure 18.

The average LS value for all locations was found to be 29.64. The lowest LS value was 1.2, while the highest LS value was 83.05 for the “C. A. Scott Recreation Bldgs”. The median LS value was 20.04, indicating that most polling locations had a layout safety of less than 40. This finding suggests that most polling locations were in line with COVID-19 rules and regulations.

Figure 19 summarizes the results of layouts based on the five main design logics. The analysis primarily focused on assessing the safety, privacy, agility, adaptability, and efficiency aspects of the polling locations. Notably, the results indicate that a significant proportion, exceeding 80% of the surveyed polling locations exhibited a safe environment, thus ensuring the well-being of the individuals involved. Furthermore, it is noteworthy that more than 95% of the polling locations successfully addressed privacy concerns, signifying a high degree of commitment to safeguarding the confidentiality of the voters. In terms of agility, a substantial majority, exceeding 80% of the assessed locations, demonstrated a responsive and flexible nature, allowing for swift adaptations as required. Likewise, the findings reveal that more than 70% of the examined polling locations exhibited adaptability, indicating their capability to effectively accommodate changes and evolving requirements. Lastly, focusing on efficiency, it is worth highlighting that over 80% of the evaluated locations were efficient.

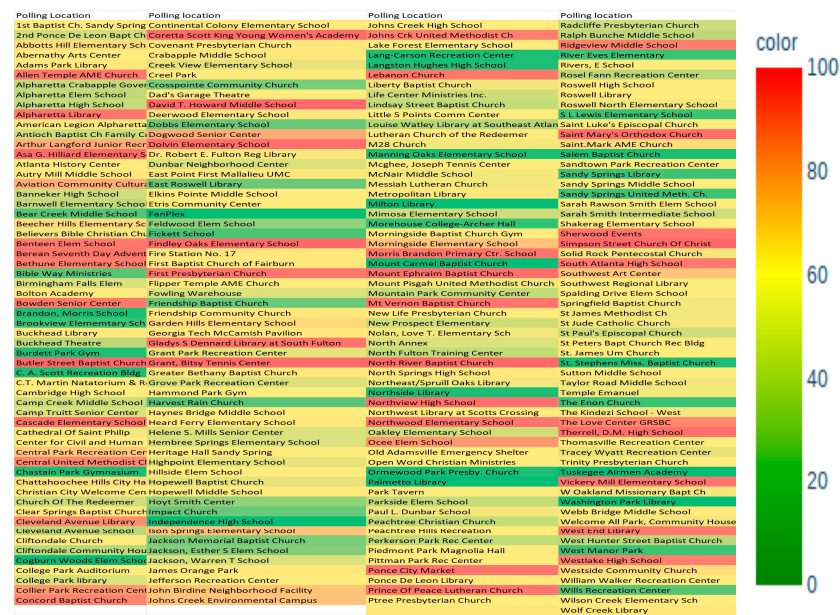

Figure 18. Heat map showing the layout safety for polling locations.



Figure 19. Overview of the layout assessment.

6. Conclusions

Current election preparation measures are inadequate for addressing significant system changes. Long lines and wait times remain a feature of the democratic process for many voters across the United States. The amount of time that voters wait in line while casting their ballots has been a matter of consternation in electorates across the world. This study proposed a methodological framework for designing and developing a simulation platform for the election system by considering the full county level in the account and aimed to minimize queue length and improve the safety and privacy perspective of polling locations.

This study's findings have several implications for election systems and polling location designers and policymakers. First, this study provides a general methodology for designing election system and highlights the importance of incorporating safety and accessibility considerations into the design layout process. Specifically, designers should aim to minimize the risk of voter interaction and ensure that polling locations are accessible to all voters, including those with disabilities.

Second, this study emphasizes the need to comply with COVID-19 regulations. Given the ongoing pandemic, it is crucial to design polling locations that minimize the risk of virus transmission. This can be achieved by ensuring that there is adequate space for social distancing, providing hand sanitizing stations, and implementing other safety measures recommended by public health authorities. It is worth mentioning that the social distancing

parameters in this study were adjusted based on the 2020 CDC recommendations rules. We acknowledge that the CDC later updated its guidelines concerning COVID-19.

Third, the developed simulator can be a useful tool for designing and evaluating election systems. Designers and policymakers can use the simulator to test different demands, resource allocations, and layout options and assess their impact on waiting time, layout safety, and resource utilization.

In summary, this study's findings suggest that designing safe and accessible polling locations that comply with COVID-19 regulations is crucial. The proposed simulator can be a valuable tool for achieving this goal, and policymakers and designers should consider using it in their decision-making processes.

Author Contributions: Conceptualization, A.V.B., B.M. and S.B.; layout methodology, A.V.B. and S.B.; software, A.V.B.; validation, B.M., D.N., F.B. and A.V.B.; formal analysis, A.V.B.; investigation, A.V.B. and S.B.; resources, A.V.B.; A.V.B.; writing—original draft preparation, A.V.B.; writing—review and editing, B.M., D.N., F.B. and R.D.; visualization, A.V.B. and S.B.; supervision, B.M. and D.N.; project administration, R.D. All authors have read and agreed to the published version of the manuscript.

Funding: We acknowledge the support of the Safe Secure Elections Project funded in part by The New America Foundation Public Interest Technology-University Network and the Georgia Tech Foundation.

Data Availability Statement: Not Applicable.

Conflicts of Interest: The authors declare no conflict of interest.

References

- Freeman, S.F.; Bleifuss, J. *Was the 2004 Presidential Election Stolen? Exit Polls, Election Fraud, and The Official Count*; Seven Stories Press: New York, NY, USA, 2011.
- Schmidt, A.; Albert, L.A. Designing pandemic-resilient voting systems. *Socio-Econ. Plan. Sci.* **2022**, *80*, 101174. [[CrossRef](#)] [[PubMed](#)]
- Stewart, C.H., III; Ansolabehere, S. *Waiting in Line to Vote*; MIT Library/MIT Open Access Articles: Cambridge, MA, USA, 2013.
- Green, D.P.; Gerber, A.S. *Get out the Vote: How to Increase Voter Turnout*; Brookings Institution Press: Washington, DC, USA, 2019.
- Stein, R.M.; Mann, C.; Stewart, C., III; Birenbaum, Z.; Fung, A.; Greenberg, J.; Kawsar, F.; Alberda, G.; Alvarez, R.M.; Atkeson, L.; et al. Waiting to vote in the 2016 presidential election: Evidence from a multi-county study. *Political Res. Q.* **2020**, *73*, 439–453. [[CrossRef](#)]
- Pettigrew, S. The downstream consequences of long waits: How lines at the precinct depress future turnout. *Elect. Stud.* **2021**, *71*, 102188. [[CrossRef](#)] [[PubMed](#)]
- Stein, R.; Mann, C.; Stewart, C. *Polling Place Quality and Access, in The Future of Election Administration*; Springer: Berlin/Heidelberg, Germany, 2020; pp. 83–100.
- Kent, M.; Parkinson, T.; Kim, J.; Schiavon, S. A data-driven analysis of occupant workspace dissatisfaction. *Build. Environ.* **2021**, *205*, 108270. [[CrossRef](#)]
- Liyang, W. *The Impact of Covid-19 on Older Adults' Perception of Public Spaces in Singapore*; National University of Singapore: Singapore, 2022.
- Cerabona, T.; Benaben, F.; Montreuil, B.; Barenji, A.V.; Nazzal, D. Physics of decision: Application to polling place risk management. In Proceedings of the 2021 Winter Simulation Conference (WSC), Phoenix, AZ, USA, 12–15 December 2021.
- Murata, T.; Konishi, K. Making a practical policy proposal for polling place assignment using voting simulation tool. *SICE J. Control. Meas. Syst. Integr.* **2013**, *6*, 124–130. [[CrossRef](#)]
- Howard, N.O.; Owens, M. Organizing Staff in the US Senate: The Priority of Individualism in Resource Allocation. In *Congress & the Presidency*; Taylor & Francis: Oxfordshire, UK, 2022.
- Au, C.H.; Xu, Z.; Wang, L.; Fung, W.S. Establishing a three-step model of designing the polling stations for shorter queue and smaller waiting time: A case study using computer simulation. *J. Inf. Technol. Case Appl. Res.* **2017**, *19*, 225–245. [[CrossRef](#)]
- Mark Niesse, N.T. Extreme voting lines expose where Georgia primary failed. *Atlanta J. Const. Atlanta J. Const.* **2021**, *2*.
- Baccaglioni, B.; Rates, S.R.; Rules, G. Georgia: 2020 Election Policies & Practices. *HealthyElection. Org* **2020**, *6*, 2011.
- Gardner, A.; Lee, M.Y.; Boburg, S. Voting debacle in Georgia came after months of warnings went unaddressed. *Wash. Post* **2020**, *2*, 5.
- Stewart, C., III. Managing polling place resources. In *Caltech/MIT Voting Technology Project*; MIT Library: Cambridge, MA, USA, 2015.
- McCool-Guglielmo, E.C.; Bernardo, N.D.; Lather, J.I.; Macht, G.A. Impact of facilities layout methods on in-person elections: A theoretical exploration. *J. Simul.* **2022**, *12*, 1–19. [[CrossRef](#)]

19. Bernardo, N.D., Jr.; King, B.A.; Macht, G.A. COVID-19 and United States Election systems: A simulation study of in-person voting in Rhode Island. *J. Simul.* **2022**, *1*–10. [[CrossRef](#)]
20. Burden, B.C.; Milyo, J. The quantities and qualities of poll workers. *Elect. Law J.* **2015**, *14*, 38–46. [[CrossRef](#)]
21. Hall, T.E.; Moore, K. *Poll Workers and Polling Places*; MIT Library: Cambridge, MA, USA, 2011.
22. Weinberg, B.H.; Utrecht, L. Problems in America’s Polling Places: How They Can Be Stopped. *Temp. Pol. Civ. Rts. L. Rev.* **2001**, *11*, 401.
23. Greene, S. The Value of the Election Administration and Voting Survey. In *The Future of Election Administration: Cases and Conversations*; Palgrave Macmillen: London, United Kingdom, 2019; pp. 241–247.
24. Merivaki, T.; Smith, D.A. A failsafe for voters? Cast and rejected provisional ballots in North Carolina. *Political Res. Q.* **2020**, *73*, 65–78.
25. Farrer, B.; Zingher, J.N. A global analysis of how losing an election affects voter satisfaction with democracy. *Int. Politi- Sci. Rev.* **2018**, *40*, 518–534. [[CrossRef](#)]
26. Coll, J. Waiting to vote safely: How Covid-19 safety measures shaped in-person voter wait times during the 2020 election. *Soc. Sci. Q.* **2022**, *103*, 380–398. [[CrossRef](#)]
27. Barenji, A.V.; Barenji, R.V.; Hashemipour, M. A framework for structural modelling of an RFID-enabled intelligent distributed manufacturing control system. *S. Afr. J. Ind. Eng.* **2014**, *25*, 48–66. [[CrossRef](#)]
28. Zou, G.; Gao, M.; Tang, J.; Yilmaz, L. Simulation of online food ordering delivery strategies using multi-agent system models. *J. Simul.* **2021**, *17*, 297–311. [[CrossRef](#)]
29. Flatt, A.; Langner, A.; Leps, O. *Model-Driven Development of Akoma Ntoso Application Profiles: A Conceptual Framework for Model-Based Generation of XML Subschemas*; Springer Nature: Berlin/Heidelberg, Germany, 2023.
30. County, F.; Fulton County Open Government. 2023 [cited 2023; In Its Commitment to Service, Efficiency and Engaging Its Citizens through An Open Government, Fulton County Offers This Site As a Portal into Its Transparency Initiatives, Including Detailed Views into the County Budget, Spending, Capital Projects and Individual Datasets Related to County Operations]. Available online: <https://data.fultoncountyga.gov/> (accessed on 1 November 2019).
31. Zhao, N.; Chong, H.-Y.; Li, Q. Agent-based modelling of helping behaviour diffusion in project teams as an evolutionary process. *J. Simul.* **2022**, *17*, 279–296. [[CrossRef](#)]
32. Gursoy, D.; Jurowski, C.; Uysal, M. Resident attitudes: A structural modeling approach. *Ann. Tour. Res.* **2002**, *29*, 79–105. [[CrossRef](#)]
33. Tao, F.; Hu, Y.; Ding, Y.; Sheng, B.; Song, C.; Zhou, Z. Modelling of manufacturing resource in manufacturing grid based on XML. In Proceedings of the 2006 4th IEEE International Conference on Industrial Informatics, Singapore, 16–18 August 2006.
34. Allen, T.T.; Yang, M.; Huang, S.; Hernandez, O.K. Method to allocate voting resources with unequal ballots and/or education. *MethodsX* **2020**, *7*, 100872. [[CrossRef](#)] [[PubMed](#)]
35. Shock, D.R. The Evolution of Partisan Voting at the County Level in Georgia, Ohio, and Texas, 1990–2016. *J. Econ. Politi.* **2020**, *25*, 1. [[CrossRef](#)]
36. Fulron County, G. Fulton County, GA. Fulton County. 2020. Available online: <https://www.fultoncountyga.gov/news/2020/11/03/november-3-election-results> (accessed on 24 September 2023).

Disclaimer/Publisher’s Note: The statements, opinions and data contained in all publications are solely those of the individual author(s) and contributor(s) and not of MDPI and/or the editor(s). MDPI and/or the editor(s) disclaim responsibility for any injury to people or property resulting from any ideas, methods, instructions or products referred to in the content.