



HAL
open science

The environmental cost of recovering energy from municipal solid waste

Jun Dong, Harish Kumar Jeswani, Ange Nzihou, Adisa Azapagic

► **To cite this version:**

Jun Dong, Harish Kumar Jeswani, Ange Nzihou, Adisa Azapagic. The environmental cost of recovering energy from municipal solid waste. *Applied Energy*, 2020, 267, pp.1-13/114792. 10.1016/j.apenergy.2020.114792 . hal-02536941

HAL Id: hal-02536941

<https://imt-mines-albi.hal.science/hal-02536941v1>

Submitted on 8 Apr 2020

HAL is a multi-disciplinary open access archive for the deposit and dissemination of scientific research documents, whether they are published or not. The documents may come from teaching and research institutions in France or abroad, or from public or private research centers.

L'archive ouverte pluridisciplinaire **HAL**, est destinée au dépôt et à la diffusion de documents scientifiques de niveau recherche, publiés ou non, émanant des établissements d'enseignement et de recherche français ou étrangers, des laboratoires publics ou privés.



Distributed under a Creative Commons Attribution 4.0 International License

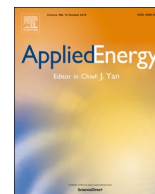

The environmental cost of recovering energy from municipal solid waste

Jun Dong^{a,b,c,*}, Harish Kumar Jeswani^c, Ange Nzihou^b, Adisa Azapagic^c

^a Key Laboratory of Recycling and Eco-treatment of Waste Biomass of Zhejiang Province, Zhejiang University of Science and Technology, 310023 Hangzhou, China

^b Université de Toulouse, IMT Mines Albi, RAPSODEE CNRS UMR-5302, Campus Jarlard, F-81013 Albi Cedex 09, France

^c Sustainable Industrial Systems, Department of Chemical Engineering and Analytical Science, The University of Manchester, Manchester M13 9PL, UK



HIGHLIGHTS

- Environmental impacts of treating flue gas from waste incinerators are assessed.
- Twelve scenarios are modelled considering combinations of eight technologies.
- Wet systems have higher environmental impacts than the dry alternatives.
- Flue gas treatment reduces significantly acidification, particle and smog formation.
- However, it generates 14 additional impacts as unintended consequences.

GRAPHICAL ABSTRACT

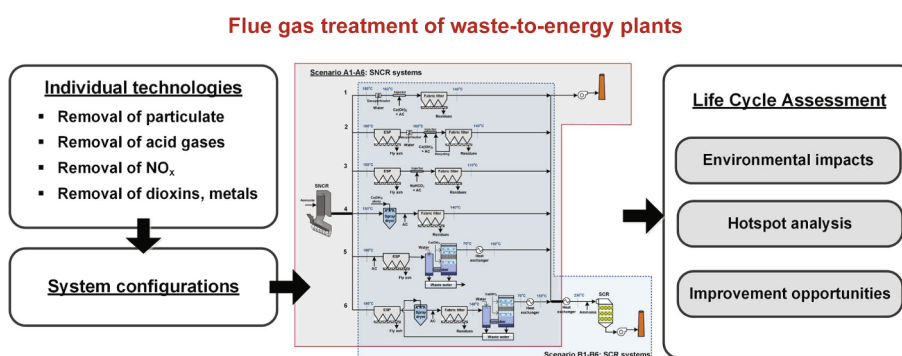

ARTICLE INFO

Keywords:

Flue gas treatment
Incineration
Life cycle assessment
Municipal solid waste
Environmental impacts

ABSTRACT

Municipal solid waste (MSW) incinerators require effective flue gas treatment (FGT) to meet stringent environmental regulations. However, this in turn generates additional environmental costs through the impacts of materials and energy used in the treatment – these impacts are currently scarcely known. Therefore, this study uses life cycle assessment to estimate the impacts of different FGT systems typically found in modern MSW incinerators. A total of 12 scenarios are modelled to consider different combinations of the following eight technologies: electrostatic precipitators and fabric filters for removal of particulate matter; dry, semi-dry and wet scrubbers for acid gases; selective non-catalytic and catalytic reduction of nitrogen oxides (NO_x); and activated carbon for removal of dioxins and heavy metals. The data are sourced from 90 full-scale incinerators operating in France. The results reveal that a dry system using sodium bicarbonate and selective non-catalytic reduction (SNCR) is the best option for seven out of 18 impacts, including climate change (37.1 kg CO₂ eq./t MSW). By contrast, a dry system with calcium hydroxide and selective catalytic reduction (SCR) has the highest impacts in six categories, including climate change (102 kg CO₂ eq./t MSW). The wet systems have higher impacts than the dry alternatives, with the semi-dry options being in between. Compared to SNCR, the use of SCR decreases the NO_x-related impacts (fine particulate matter formation, terrestrial acidification and photochemical ozone formation) but increases other impacts. For example, the SCR systems have 49–284% greater climate change and 43–150% higher depletion of fossil resources than their SNCR counterparts. Overall, all FGT systems reduce significantly fine particulate matter formation (by 81–88%), photochemical ozone formation (76–90%) and terrestrial acidification (83–90%). However, they also cause 14 other impacts which would not be generated if the flue gas was left untreated, thus creating additional environmental costs. These include climate change,

* Corresponding author at: Zhejiang University of Science and Technology, 310023 Hangzhou, China.

E-mail address: dongjun@zust.edu.cn (J. Dong).

<https://doi.org/10.1016/j.apenergy.2020.114792>

Received 21 December 2019; Received in revised form 8 February 2020; Accepted 1 March 2020

0306-2619/© 2020 The Authors. Published by Elsevier Ltd. This is an open access article under the CC BY license (<http://creativecommons.org/licenses/by/4.0/>).

resource depletion and human and ecotoxicities. Therefore, these trade-offs should be considered carefully to minimise the unintended environmental consequences of flue gas treatment from incineration of MSW.

Nomenclature

APC	air pollution control	LU	land use
BAT	best available techniques	MC	Monte Carlo
CC	climate change	MD	metal depletion
ESP	electrostatic precipitators	ME	marine eutrophication
FC	freshwater consumption	MEco	marine ecotoxicity
FD	fossil depletion	MSW	municipal solid waste
FE	freshwater eutrophication	PM	particular matter
FEco	freshwater ecotoxicity	POF-E	photochemical ozone formation-ecosystems
FGT	flue gas treatment	POF-HH	photochemical ozone formation-human health
FPMF	fine particulate matter formation	SCR	selective catalytic reduction
HT-C	human toxicity-cancer	SNCR	selective non-catalytic reduction
HT-N	human toxicity-non-cancer	SOD	stratospheric ozone depletion
I-TEQ	international-toxic equivalent quantity	SR	sensitivity ratio
IR	ionizing radiation	TA	terrestrial acidification
LCA	life cycle assessment	TE	terrestrial ecotoxicity
		VOCs	volatile organic compounds

1. Introduction

In recent times, the role of municipal solid waste (MSW) incinerators has shifted from diverting waste streams from landfills to be used for energy provision [1,2]. In the EU, 28% of the MSW is incinerated [3]. In France, for instance, this figure is even higher (32%), with 114 incineration plants treating 14.4 Mt/yr of MSW [4].

However, MSW incineration still faces public opposition in some countries and regions. The major issue around this debate is mainly associated with the generation of toxic pollutants [5]. To minimise the environmental and human health impacts associated with MSW incineration, the EU Directive 2000/76/EC [6] set stringent operational conditions and technical requirements for MSW incineration plants, and was subsequently integrated into the Directive 2010/75/EU [7] for different types of industrial plants. Meeting the requirements of the Directive requires a range of flue gas treatment (FGT) technologies to remove target pollutants, including [8,9]:

- electrostatic precipitators (ESP), fabric filters, cyclones and venturi scrubbers for removal of fly ash and particulates;
- dry, semi-dry and wet scrubbers for abatement of acid gases, such as hydrogen chloride (HCl), hydrogen fluoride (HF) and sulphur dioxide (SO₂);
- selective non-catalytic reduction (SNCR) and selective catalytic reduction (SCR) for control of nitrogen oxides (NO_x); and
- activated carbon for adsorption of organic pollutants, such as dioxins, and volatile heavy metals, such as mercury.

Given that no single FGT technology can abate all target pollutants, the FGT system typically consists of a combination of aforementioned processes. This leads to the need to select an optimal system configuration to maximise its efficiency and minimise the overall environmental impacts. The environmental impacts of such systems can be compared using life cycle assessment (LCA), which quantifies both direct and indirect impacts of a system across its life cycle [10,11]. To date, LCA has been applied extensively to evaluating the environmental performance of MSW incinerators. However, the existing studies have mostly considered incineration plants [5,12,13], rather than FGT technologies [14]. Those studies that have considered the latter have mostly focused on individual FGT technologies, such as NO_x reduction [15] and acid removal [16], rather than their integration within a system.

Therefore, this paper sets out to determine environmentally the most sustainable FGT systems considering an extensive set of possible configurations. Eight FGT technologies incorporated into 12 different system configurations are evaluated on their environmental performance using LCA. The results are compared to the impacts from untreated flue gas to identify the benefits from the treatment as well as any additional environmental costs related to the unintended environmental consequences of the treatment. The results can be used to guide improvements of existing and sustainable development of future FGT systems for MSW incineration. To the authors' knowledge, this is the first study of its kind internationally.

The next section provides an overview of LCA studies of FGT technologies available in the literature. This is followed in Section 3 by the methods and models used in the study. The results are presented in Section 4 and the conclusions are drawn in Section 5.

2. Literature review

A number of LCA studies assessed environmental impacts of FGT technologies. However, most focused on acid gases and NO_x removal, while technologies for removal of particulates, heavy metals and organic pollutants were rarely discussed. An example of the study that considered removal of both acid gases and particulates is that by Chevalier et al. [17] who analysed the environmental footprint of a transported-droplets column. The results confirmed its environmental viability in comparison with a conventional wet scrubber due to a higher efficiency in capturing particulates and acid gases, particularly if coupled with an ESP. The latter was also considered by Wu et al. [18], who compared it with wet flue gas desulphurisation and SCR, finding that ESP had the lowest resource and energy consumption.

Technologies for removal of acid gases were examined by Dal Pozzo et al. [19] to identify a better design solution between a dry, a semi-dry and a wet system. Benefits and limits of each alternative technology were discussed from both environmental and economic perspectives. Two other studies also focused on such systems: Perazzini et al. [16], who compared one- and two-stage systems, and Biganzoli et al. [20], who evaluated the impacts of using a high-temperature dolomitic sorbent as a preliminary stage for acid-gases treatment. In the latter, a typical dry acid gases removal based on sodium bicarbonate (NaHCO₃) was considered and the results showed that the production of the reagent and treatment of solid residues were the key environmental

hotspots. However, the recovery of the residual sodium salts led to a reduction in the impacts. The acid gases removal technologies were also studied for coal-fired power plants. For example, Feng et al. [21] compared wet and circulating fluidised bed desulphurisation processes finding that the former was environmentally a better option. Xu and Hou [22] also evaluated the impacts of wet fluidised bed desulphurisation, showing that the acidification potential could be reduced by 97%.

In assessing SNCR in a full-scale MSW incinerator, Møller et al. [23] found that the environmental impacts associated with ammonia (NH₃) slip may outweigh the saved impacts from NO_x removal, highlighting an optimal balance between NH₃ dosage and NO_x removal. SNCR was also considered by Liang et al. [24], who compared it with SCR, reporting that the latter had lower life cycle impacts due to a more efficient removal of NO_x. However, these findings contrasted those of Van Caneghem et al. [15] who found that SCR was less preferable than SNCR due to the additional impacts from catalyst manufacture and reheating of flue gas.

As can be seen from this review, most LCA studies focused on individual FGT technologies and those that considered integrated systems incorporating different treatment methods are scarce. An example is the work by Damgaard et al. [25] who analysed historical development of FGT processes in Danish MSW incinerators over the last 40 years and the related change in environmental impacts. In another study, Scipioni et al. [26] compared two design alternatives in Italy: a dry (two-stage calcium hydroxide (Ca(OH)₂) and NaHCO₃ dry scrubber + SCR) and a wet FGT (SNCR + NaHCO₃ dry scrubber + sodium hydroxide (NaOH) wet scrubber). Similar studies were also carried out by Wen et al. [27] and Cui et al. [28] in the Chinese context. The former analysed a potential for using different combinations of FGT technologies in a specific MSW incineration plant, while the latter compared environmental and economic effects of a coal-fired plant before and after ultra-clean emission retrofit. However, the FGT technologies and system designs considered in all these studies were limited in scope and in the impacts considered. Hence, this study aims to fill this knowledge gap by evaluating a comprehensive set of LCA impacts of a broad range of FGT technologies and their system configurations, focusing on modern MSW incinerators.

3. Methodology

The LCA study follows the guidelines in the ISO 14040/44 standards [29,30]. In congruence with the standards, all four LCA methodological phases are considered as follows: (1) goal and scope definition is discussed next; (2) life cycle inventory is detailed in Section 3.2; (3) life cycle impact assessment is described in Section 3.3; and (4) interpretation of the results is provided in Section 4.

3.1. Goal and scope

The goal of this work is to quantify the life cycle environmental impacts of flue gas treatment in MSW incinerators. For these purposes, the study estimates and compares the environmental impacts of different FGT systems and their configurations in real MSW incineration plants to determine environmentally the most sustainable options. In addition, the study also considers the impacts of untreated flue gas in comparison with the impacts of its treatment. While discharging untreated flue gas would not be permitted due to legislation, it is still important to determine any unintended consequences of its treatment and the related environmental costs.

The evaluation is based on an attributional approach, in congruence with the goal of the study [31,32].

As indicated in Fig. 1, the system boundaries include the following life cycle stages and processes:

- energy and materials used for FGT, such as reagents, process water, electricity, heat, etc.;

- operation of the FGT system;
- wastewater treatment, for wet systems;
- disposal of fly ash and air pollution control (APC) residues which are stabilised, transported and disposed of in hazardous landfill sites; and
- recycling of reagents, where applicable.

The construction of FGT equipment is excluded due to a lack of data.

The functional unit is defined as “incineration of 1 tonne of MSW”, which is equivalent to the treatment of 5250 Nm³ of flue gas; for further detail on the latter, see Section 3.2.2.

3.2. Life cycle inventory

This section first provides an overview of the system considered, followed by the inventory data and assumptions.

3.2.1. System description

The following eight FGT technologies are considered in the study, incorporated into 12 different system configurations (scenarios):

- EPS and fabric filters for particular matter (PM);
- dry, semi-dry and wet scrubbers for acid gases;
- SNCR and SCR for NO_x; and
- activated carbon for organic pollutants and heavy metals.

The scenarios are illustrated in Fig. 2, with half using SNCR (scenarios A1-A6) and the other half SCR (scenarios B1-B6). Both the FGT technologies and the scenarios considered in the study are representative of those widely employed in modern MSW incineration plants around the world. The scenarios are described in the next sections; the technologies included in each scenario are summarised in Table S1 in the Supplementary Material (SM).

3.2.1.1. SNCR systems: Scenarios A1-A6. In these scenarios, FGT starts with SNCR of NO_x, which is performed in the post-combustion chamber. SNCR operates at temperatures of around 900–1000 °C, with liquid ammonia injected into the hot flue gas. The flue gas is then cooled and the heat recovered to be used. The temperature after SNCR and heat recovery is assumed at 180 °C as a typical value [19].

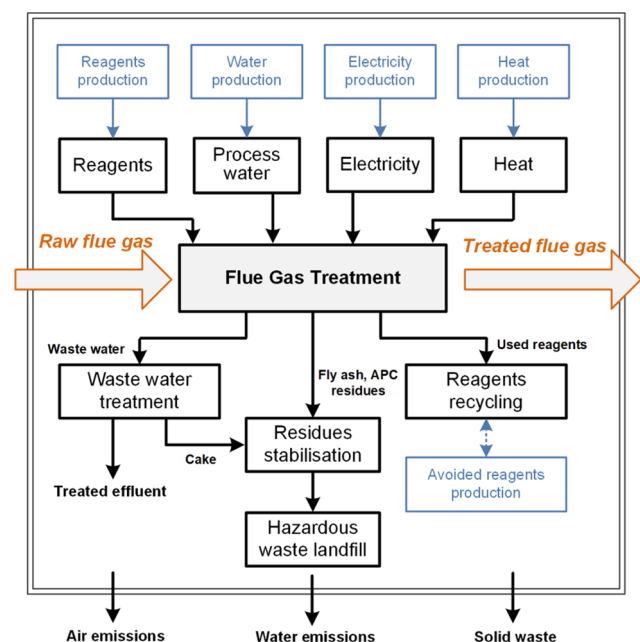

Fig. 1. System boundaries considered in the study (APC: air pollution control).

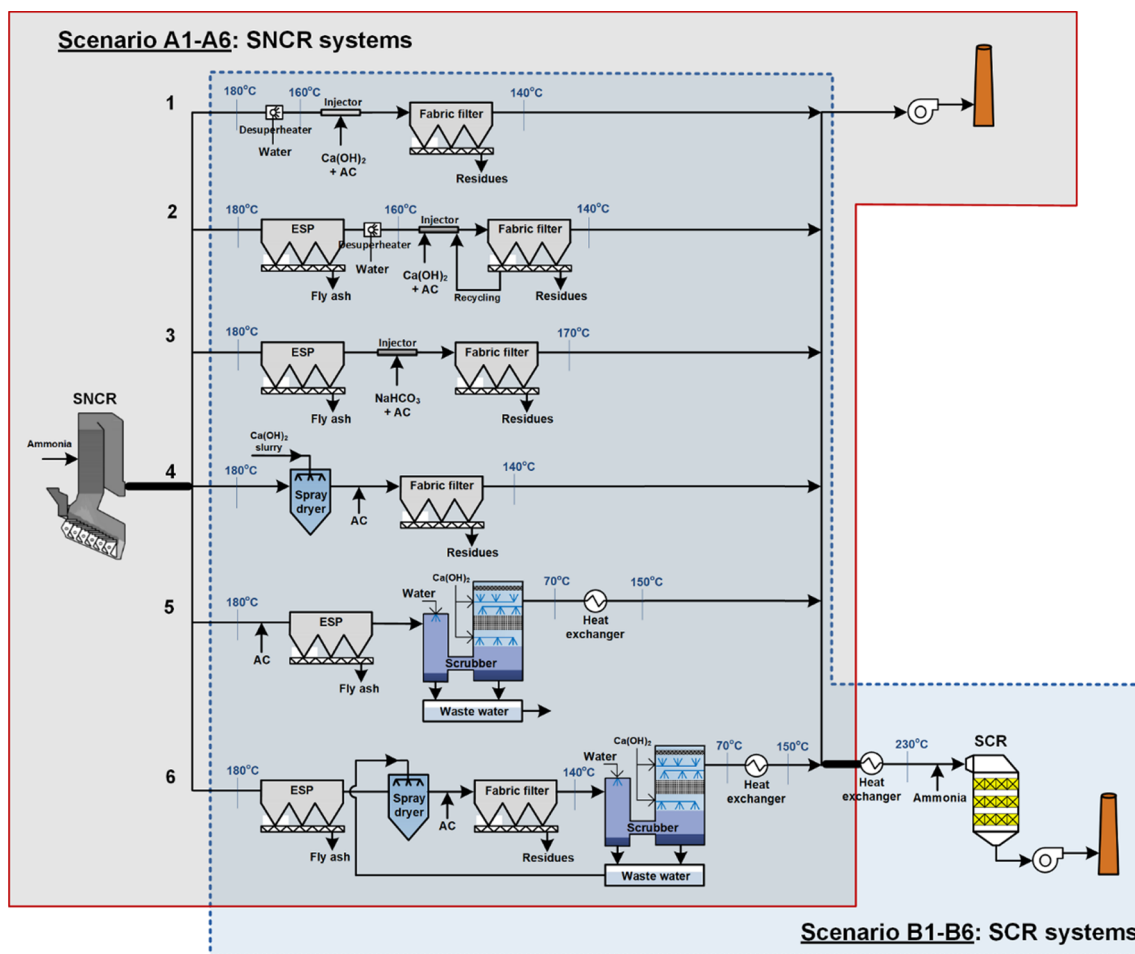

Fig. 2. Flue gas treatment scenarios considered in the study (ESP: electrostatic precipitator; AC: activated carbon. The solid red line denotes the system boundaries for scenarios A1-A6 and dotted blue line the boundaries for scenarios B1-B6).

This value is used to quantify the potential for recovering flue gas energy in wet systems (for details, see Section 4.5.1), as wet FGT systems do not require a theoretical minimum inlet temperature [33]. Note that lowering the flue gas temperature at the boiler outlet is limited by the acid dew point. In practice, the minimum inlet temperature for semi-dry FGT system may exceed 190 °C because water injection in spray dryers decreases the flue gas temperature. Dry FGT systems using NaHCO₃ require a minimum inlet temperature of 170 °C to ensure its reactivity [33].

A1 is based on a dry system for the clean-up of acid gases, using slaked lime (Ca(OH)₂) as the reagent. The reagent is injected directly into the gas duct to adsorb the gaseous pollutants. By adding activated carbon along with Ca(OH)₂, this process allows simultaneous removal of organic pollutants and mercury. The reaction products, known as APC residues, are captured together with particulates in a downstream fabric filter. In order to optimise the chemical reactions with Ca(OH)₂, the flue gas has to be pre-conditioned. This is carried out by injecting water to cool down the flue gas to 140–180 °C (assumed at 160 °C in this study) as well as to increase humidity [8]. One major advantage of the A1 system is its simple operation; thus, it is widely used in incineration plants. However, this consumes large quantities of Ca(OH)₂, often two or three times more than required stoichiometrically [33], and generates additional waste that need to be disposed of.

A2 is an evolution of A1, with an additional upstream ESP prior to the injection of Ca(OH)₂ and activated carbon. The main advantage of this process is the preliminary separation of fly ash. This permits the recycling of a part of the residues in the downstream fabric filter, containing un-reacted Ca(OH)₂, to be fed back into the flue gas. As a

result, the final APC residues sent for disposal can be reduced significantly.

A3 is also a dry process, but instead of Ca(OH)₂ it uses NaHCO₃ for the reaction with acid gases. Unlike the lime-based sorbent, it does not require any pre-conditioning of the flue gas. Residues from the ESP contain mainly fly ash, while those from the fabric filter are mainly sodium salts, such as sodium chloride (NaCl), sodium fluoride (NaF) and sodium sulphate (Na₂SO₄). Based on the general practice in modern incinerators, the sodium salts are assumed to be recovered and used as raw materials for the production of sodium carbonate (Na₂CO₃).

A4 uses a semi-dry process for removal of acid gases. The aim is to improve the reactivity of the reagent – as the rate of the gas–water reaction is higher than that of the gas–solid reaction – which implies that the quantity of the consumed reagent can be decreased [34]. The Ca(OH)₂ reagent is first mixed with water and the slurry is then injected into a spray dryer. The acid pollutants are adsorbed onto the reagent while the water evaporates due to high temperature of the flue gas, leaving behind solid residue. This process is followed by injecting activated carbon for the abatement of mainly dioxins and mercury, or alternatively, the activated carbon can be mixed with Ca(OH)₂. Finally, a downstream fabric filter is installed to collect the APC residues. An outlet temperature of > 140 °C is usually required for the spray dryer to avoid dew-point corrosion in the fabric filter [8].

A5 represents a wet process, which involves the use of aqueous solution to extract the pollutants from the flue gas and generates a liquid residue. The process is performed in two stages: first, HCl and HF are removed in a water scrubber, followed by absorption of SO₂ in a Ca(OH)₂ scrubber. This method is used especially in large-scale plants

[35], owing to a more favourable stoichiometry of the consumed reagent and a higher removal efficiency. However, the main drawback is that it generates a large volume of wastewater containing high concentrations of salts and metal compounds, which requires further treatment. Since the temperature of flue gas after passing through the wet scrubber falls to $\sim 70^\circ\text{C}$, the flue gas is reheated above the dew point of acid gases (assumed at 150°C) before being discharged into the atmosphere to avoid corrosion and a visible plume from the stack [36].

A6 is also a wet system but it is designed to be wastewater-free. This process is based on the fact that in most countries the discharge of saline effluent is not allowed [37]. The wastewater is injected into a spray dryer and is evaporated by the heat of the flue gas. The vaporised residues are then removed by a fabric filter upstream of the scrubbing process.

3.2.1.2. SCR systems: Scenarios B1-B6. The B1-B6 scenarios differ from A1-A6 only in the removal of NO_x : instead of SNCR, they rely on a tail-end SCR process placed just before the stack. In contrast to SNCR, SCR is carried out at a lower temperature ($180\text{--}450^\circ\text{C}$) with the addition of a catalyst. However, as the flue gas exiting the wet scrubber or fabric filter is at a temperature of $70\text{--}170^\circ\text{C}$, which is too low for the catalytic reduction of NO_x , reheating of the flue gas to 230°C is necessary [15]. As in the SNCR systems, liquid ammonia is also used as the reducing agent.

3.2.2. Inventory data and assumptions

The inventory data have been obtained from 90 full-scale incineration plants operating in France (71% of the total number of plants) over the period 2012–2015 [35,38]. The incinerators in France have been selected due to the availability of detailed data. These are also representative of modern incinerators operated in the rest of the EU, as well as in other developed countries and world regions. The modelling of the systems has been carried out based on the detailed mass and energy flows in each of the 12 systems, including the waste composition, in accordance with recommendations from Astrup et al. [14].

The waste composition is estimated as an average of French residual MSW, with a flue gas volume of $5250\text{ Nm}^3/\text{t MSW}$ [39]. The concentration of key pollutants in the raw flue gas is determined considering typical data from MSW incineration plants, listed in Table 1 together with the emission limits for the incinerators in the EU [8]. The stack emissions after the FGT are specified for the different scenarios in the next section.

3.2.3. Stack emissions

The concentrations of various pollutants in stack emissions vary among FGT systems. For all of the 12 scenarios considered, stack emissions of the key pollutants (PM, HCl, SO_2 , dioxins, NO_x , NH_3 and nitrous oxide (N_2O)), are compiled in Table 2. These have been sourced mainly from measurements in the 90 French incineration plants [35,38]. The data represent a median value of emissions which are used in the base-case analysis, while the minimum and maximum values are used in sensitivity and uncertainty analyses. In addition, the following assumptions are made:

- Only the emissions that are primarily affected by the FGT systems are considered [40]. Carbon dioxide (CO_2) emissions from the combustion of MSW are assumed to be same in all the scenarios, hence not considered here. CO and volatile organic compounds (VOCs) are excluded because FGT is not designed for their abatement. Although different FGT systems influence the concentration of heavy metals in stack emissions [41], they are not considered due to a lack of data.
- The emissions of particulate matter are assumed to be 99.5% $\text{PM}_{2.5}$ and 0.5% $\text{PM}_{2.5-10}$. In the absence of specific data for France, this is based on measurements in Swiss incineration plants [42] but the difference in PM composition between the two countries is expected to be small.

- The stack emissions of NH_3 are a consequence of NH_3 slip due to the use of SNCR and SCR. There is no ammonia in stack emissions in scenarios A5 and A6 (wet SNCR-based configuration) as ammonia is highly soluble in water and is thus captured in the wet scrubber [23].
- The N_2O emissions are mainly a by-product of the NO_x reduction technology [43]. These emissions are accounted for in the study, although they are currently not subject to emission limits at the stack. The N_2O emissions have been sourced from the Waste Incineration Life Cycle Inventory (WILCI) tool [38]. For SNCR with dioxin abatement, the N_2O emissions are $8\text{ mg}/\text{Nm}^3$ and $5\text{ mg}/\text{Nm}^3$ for the equivalent SCR system.

3.2.4. Consumption of materials

Input materials used for FGT include reagents ($\text{Ca}(\text{OH})_2$ or NaHCO_3) for the abatement of acid gases, activated carbon for dioxins, liquid ammonia for NO_x and process water for scrubbers. SCR also requires a catalyst, which is most commonly based on titanium dioxide (TiO_2) as carrier with vanadium pentoxide (V_2O_5) as active component and tungsten trioxide (WO_3) as promoter [44]. The quantities of these materials are summarised in Table 3. For some of the data, the variations between the minimum and maximum are also available which are used in the sensitivity and uncertainty analyses.

Life cycle inventories for these materials are sourced from the ecoinvent database v3.3 [45]. A summary of the data sources is provided in Table S2 in the SM.

Since the ecoinvent database does not include data on the production of NaHCO_3 , this is modelled based on the approach suggested by Pacher et al. [46]. It is produced via the reaction of Na_2CO_3 with water and CO_2 according to:

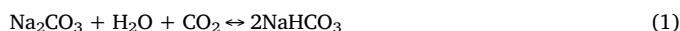

For the production of 1 kg of NaHCO_3 , 0.631 kg of Na_2CO_3 , 0.126 L of water, 0.309 kg of CO_2 and 0.336 MJ of electricity are required. In addition, CO_2 is generated during the use of NaHCO_3 when it is injected into the flue gas, according to the reverse reaction in Eq. (1). Based on the stoichiometric calculation, 262 g of CO_2 are emitted per kg of NaHCO_3 [20], and these emissions are also accounted for.

For the SCR catalyst, life cycle inventory data for TiO_2 are used as a proxy since TiO_2 is the major constituent. The remaining materials, for which reliable production data are not available, are used in very small quantities and are not expected to affect the results.

3.2.5. Energy consumption

Table 4 details the electricity and heat consumption for the operation of the FGT system in different scenarios. The electricity consumption by individual FGT technologies is estimated according to the

Table 1

Typical daily average concentrations of target pollutants in raw flue gas and their emission limits in the EU.^a

Pollutant	Raw gas concentration before FGT		EU limits for stack emissions ^c
	Typical ranges ^b	Value considered in this study	
Particulate matter (mg/Nm ³)	1000–5000	3000	10
HCl (mg/Nm ³)	500–2000	1000	10
SO_2 (mg/Nm ³)	150–400	400	30
NO_x (mg/Nm ³)	200–500	350	150
Dioxins (ng I-TEQ/Nm ³) ^d	1–10	5.5	0.1

^a At 273 K, 101.3 kPa and 11 vol% O_2 .

^b Source: Vehlow [8].

^c Source: European Commission [7].

^d I-TEQ: International-Toxic Equivalent Quantity.

Table 2
Stack emissions for different flue gas treatment scenarios (g/t MSW).^a

Pollutant	Scenarios					
	SNCR^b					
	A1	A2	A3	A4	A5	A6
Particulate matter	6.05 (0.82–51.7)	5.07 (0.32–18.8)	5.07 (0.32–18.8)	3.43 (0.41–22.1)	3.82 (0.26–25.6)	3.82 (0.26–25.6)
HCl	33.1 (0.60–64.1)	33.1 (0.60–64.1)	33.1 (0.60–64.1)	21.3 (3.80–53.0)	4.70 (0.10–20.3)	4.70 (0.10–20.3)
SO ₂	43.1 (2.50–196)	43.1 (2.50–196)	43.1 (2.50–196)	56.4 (3.50–190)	35.5 (1.80–230)	35.5 (1.80–230)
Dioxins	4.80 × 10 ⁻⁸ (0–3.13 × 10 ⁻⁷)	4.80 × 10 ⁻⁸ (0–3.13 × 10 ⁻⁷)	4.80 × 10 ⁻⁸ (0–3.13 × 10 ⁻⁷)	4.80 × 10 ⁻⁸ (0–3.13 × 10 ⁻⁷)	4.80 × 10 ⁻⁸ (0–3.13 × 10 ⁻⁷)	4.80 × 10 ⁻⁸ (0–3.13 × 10 ⁻⁷)
NO _x	813 (305–2668)	813 (305–2668)	813 (305–2668)	813 (305–2668)	813 (305–2668)	813 (305–2668)
NH ₃	17.0 (0–43.4)	17.0 (0–43.4)	17.0 (0–43.4)	17.0 (0–43.4)	0	0
N ₂ O	42.0	42.0	42.0	42.0	42.0	42.0
	SCR^b					
	B1	B2	B3	B4	B5	B6
Particulate matter	6.05 (0.82–51.7)	5.07 (0.32–18.8)	5.07 (0.32–18.8)	3.43 (0.41–22.1)	3.82 (0.26–25.6)	3.82 (0.26–25.6)
HCl	33.1 (0.60–64.1)	33.1 (0.60–64.1)	33.1 (0.60–64.1)	21.3 (3.80–53.0)	4.70 (0.10–20.3)	4.70 (0.10–20.3)
SO ₂	43.1 (2.50–196)	43.1 (2.50–196)	43.1 (2.50–196)	56.4 (3.50–190)	35.5 (1.80–230)	35.5 (1.80–230)
Dioxins	3.40 × 10 ⁻⁸ (0–1.82 × 10 ⁻⁷)	3.40 × 10 ⁻⁸ (0–1.82 × 10 ⁻⁷)	3.40 × 10 ⁻⁸ (0–1.82 × 10 ⁻⁷)	3.40 × 10 ⁻⁸ (0–1.82 × 10 ⁻⁷)	3.40 × 10 ⁻⁸ (0–1.82 × 10 ⁻⁷)	3.40 × 10 ⁻⁸ (0–1.82 × 10 ⁻⁷)
NO _x	297 (107–812)	297 (107–812)	297 (107–812)	297 (107–812)	297 (107–812)	297 (107–812)
NH ₃	4.75 (0.05–83.3)	4.75 (0.05–83.3)	4.75 (0.05–83.3)	4.75 (0.05–83.3)	4.75 (0.05–83.3)	4.75 (0.05–83.3)
N ₂ O	26.3	26.3	26.3	26.3	26.3	26.3

^a The stack emissions are estimated based on the volume of flue gas of 5250 Nm³/t MSW.

^b Values in brackets represent the minimum and maximum emissions, with the median value used in the base case.

Table 3
Consumption of materials in different flue gas treatment scenarios (kg/t MSW).^a

Material	Scenarios					
	SNCR^b					
	A1	A2	A3	A4	A5	A6
Slaked lime	14.6	7.35 ^c	–	11.6 (3.26–19.4)	3.67	3.67
Sodium bicarbonate	–	–	13.2 (6.07–19.0)	–	–	–
Activated carbon	0.56 (0.20–1.50)	0.56 (0.20–1.50)	0.56 (0.20–1.50)	0.56 (0.20–1.50)	0.56 (0.20–1.50)	0.56 (0.20–1.50)
Liquid ammonia	0.52 (0.36–3.97)	0.52 (0.36–3.97)	0.52 (0.36–3.97)	0.52 (0.36–3.97)	0.52 (0.36–3.97)	0.52 (0.36–3.97)
Process water	250	250	–	550	1100	1100
	SCR^b					
	B1	B2	B3	B4	B5	B6
Slaked lime	14.6	7.35	–	11.6 (3.26–19.4)	3.67	3.67
Sodium bicarbonate	–	–	13.2 (6.07–19.0)	–	–	–
Activated carbon	0.47 (0.15–0.70)	0.47 (0.15–0.70)	0.47 (0.15–0.70)	0.47 (0.15–0.70)	0.47 (0.15–0.70)	0.47 (0.15–0.70)
Liquid ammonia	0.53 (0.06–3.25)	0.53 (0.06–3.25)	0.53 (0.06–3.25)	0.53 (0.06–3.25)	0.53 (0.06–3.25)	0.53 (0.06–3.25)
TiO ₂ as catalyst	5.08 × 10 ⁻²	5.08 × 10 ⁻²	5.08 × 10 ⁻²	5.08 × 10 ⁻²	5.08 × 10 ⁻²	5.08 × 10 ⁻²
Process water	250	250	–	550	1100	1100

^a The values exclude materials used for waste treatment.

^b Values in brackets represent the minimum and maximum emissions, with the average values used in the base case.

^c Taking into account that 7.25 kg/t MSW of the used Ca(OH)₂ is recirculated in scenarios A2 and B2.

Best Available Techniques (BAT) for waste incineration [33]. Reheating of flue gas exiting the wet scrubber is required for plume suppression and for the operation of SCR. The required heat is calculated based on flue gas composition and temperature differences. The heat is assumed

to be provided by natural gas. The life cycle inventory data for both French grid electricity and the heat from natural gas are obtained from theecoinvent database.

Table 4
Consumption of energy in different flue gas treatment scenarios (MJ/t MSW).^a

Energy	Scenarios					
	SNCR					
	A1	A2	A3	A4	A5	A6
Electricity	39.6	82.8	82.8	41.4	119	151
Heat	–	–	–	–	1054	1054
	SCR					
	B1	B2	B3	B4	B5	B6
Electricity	61.2	104	104	63.0	140	173
Heat	819	819	546	819	1782	1782

^a The values exclude the energy used for waste treatment.

3.2.6. Waste management

The waste management data are summarised in Table 5. Wastewater resulting from the wet-type systems (A5, B5) is discharged to an on-site treatment unit. The treatment is assumed to be a physico-chemical process as reported in the BAT document [33], which generally involves neutralisation, flocculation and dewatering of the precipitated sludge. The volume of wastewater amounts to 30% of the input process water as the rest is evaporated and/or re-used [33]. The amount of lime needed for neutralisation of the wastewater is based on the amount of captured HCl and SO₂. Flocculation is carried out with agents (poly-electrolytes) and FeCl₃; they are used in small quantities and are not considered due to a lack of data. The amount of sludge is a sum of the precipitated calcium sulphites, sulphates and metal compounds, at a moisture content of 20% wt. The sludge is treated further in a similar way to other solid residues, as discussed below. The treated effluent is assumed to comply with the related EU standard [6]. The electricity required to drive the equipment is estimated at 3.29 MJ/m³ wastewater [47], equivalent to 1.09 MJ/t MSW.

In A6 and B6 scenarios, the wastewater is injected into a spray dryer after a neutralisation step. The water evaporates and the soluble salts are captured by a downstream fabric filter.

The amount of fly ash and APC residues is estimated as a sum of the added reagents and the captured pollutants, by considering their

Table 5
Waste management data for different flue gas treatment scenarios (kg/t MSW).

Waste, energy and materials	Scenarios					
	SNCR					
	A1	A2	A3	A4	A5	A6
Wastewater	–	–	–	–	330	–
Fly ash and APC residues	38.2	30.9	36.8	35.2	16.1	24.3
Sludge	–	–	–	–	6.33	6.11
Reagent recycling	–	7.25 (recirculated)	20.7 (brine recovery)	–	–	–
Lime for wastewater treatment	–	–	–	–	4.03	4.03
Ferrox for solid stabilisation	3.05	2.47	1.29	2.81	1.80	2.43
Electricity for wastewater treatment, MJ/t-MSW	–	–	–	–	1.09	1.09
Electricity for solid stabilisation ^a	0.36	0.29	0.15	0.33	0.21	0.29
Diesel for solid stabilisation ^b	0.02	0.02	0.01	0.02	0.01	0.02
	SCR					
	B1	B2	B3	B4	B5	B6
Wastewater	–	–	–	–	330	–
Fly ash and APC residues	38.1	30.8	36.7	35.1	16.0	24.2
Sludge	–	–	–	–	6.33	6.11
Reagent recycling	–	7.25 (recirculated)	20.7 (brine recovery)	–	–	–
Lime for wastewater treatment	–	–	–	–	4.03	4.03
Ferrox for solid stabilisation	3.05	2.47	1.29	2.81	1.79	2.42
Electricity for wastewater treatment, MJ/t-MSW	–	–	–	–	1.09	1.09
Electricity for solid stabilisation ^a	0.36	0.29	0.15	0.33	0.21	0.29
Diesel for solid stabilisation ^b	0.02	0.02	0.01	0.02	0.01	0.02

^a Expressed in MJ/t MSW.

^b Expressed in L/t MSW.

concentrations in the raw and cleaned flue gas. The residues are assumed to be chemically stabilised by the Ferrox process, the data for which are from Fruergaard et al. [48]. The treated residues are sent to a hazardous landfill [4]. The transportation distance is assumed at 200 km.

Reagent recycling is considered in Scenarios A2, B2, A3 and B3. Part of the Ca(OH)₂-containing residues is recirculated back to the flue gas in A2 and B2 for better utilisation of the reagent. The recycled amount is determined as an excess of Ca(OH)₂ over the theoretical minimum required for SO₂ and HCl removal. In A3 and B3, the residual sodium salts as reaction products of NaHCO₃ are sent for brine recovery based on the NEUTREC process [8]. The treatment of 1 kg of sodium salts requires 0.108 MJ of electricity and produces 0.743 kg of NaCl, while generating 0.146 kg of solid residues [20]. The recovered NaCl is credited to the system, avoiding the related impacts from its conventional production. The residues are also disposed of in a hazardous landfill located 200 km away from the incineration facility.

3.2.7. Sensitivity and uncertainty analyses

The reliability of the results is explored through both sensitivity and uncertainty analyses. For the former, a perturbation analysis is used to identify input parameters that are crucial to the model outputs. Each input parameter is varied individually based on an arbitrary change ($\pm 10\%$), assuming that all other parameters are constant at their average levels. The associated sensitivity ratio (SR), i.e. the ratio of the relative change of the model output to that of the input parameter, is calculated to examine the variation in the results:

$$SR = \frac{\Delta \text{result}/\text{baseline result}}{\Delta \text{input parameter}/\text{baseline input parameter}} \quad (2)$$

The uncertainty analysis uses Monte Carlo (MC) simulation with 10,000 iterations to explore the effect of the variations in the inventory data, particularly for the stack emissions and consumption of reagents (Table 2 and Table 3). Uniform distributions between minimum and the maximum values are assumed for all values due to a lack of information on their actual distributions.

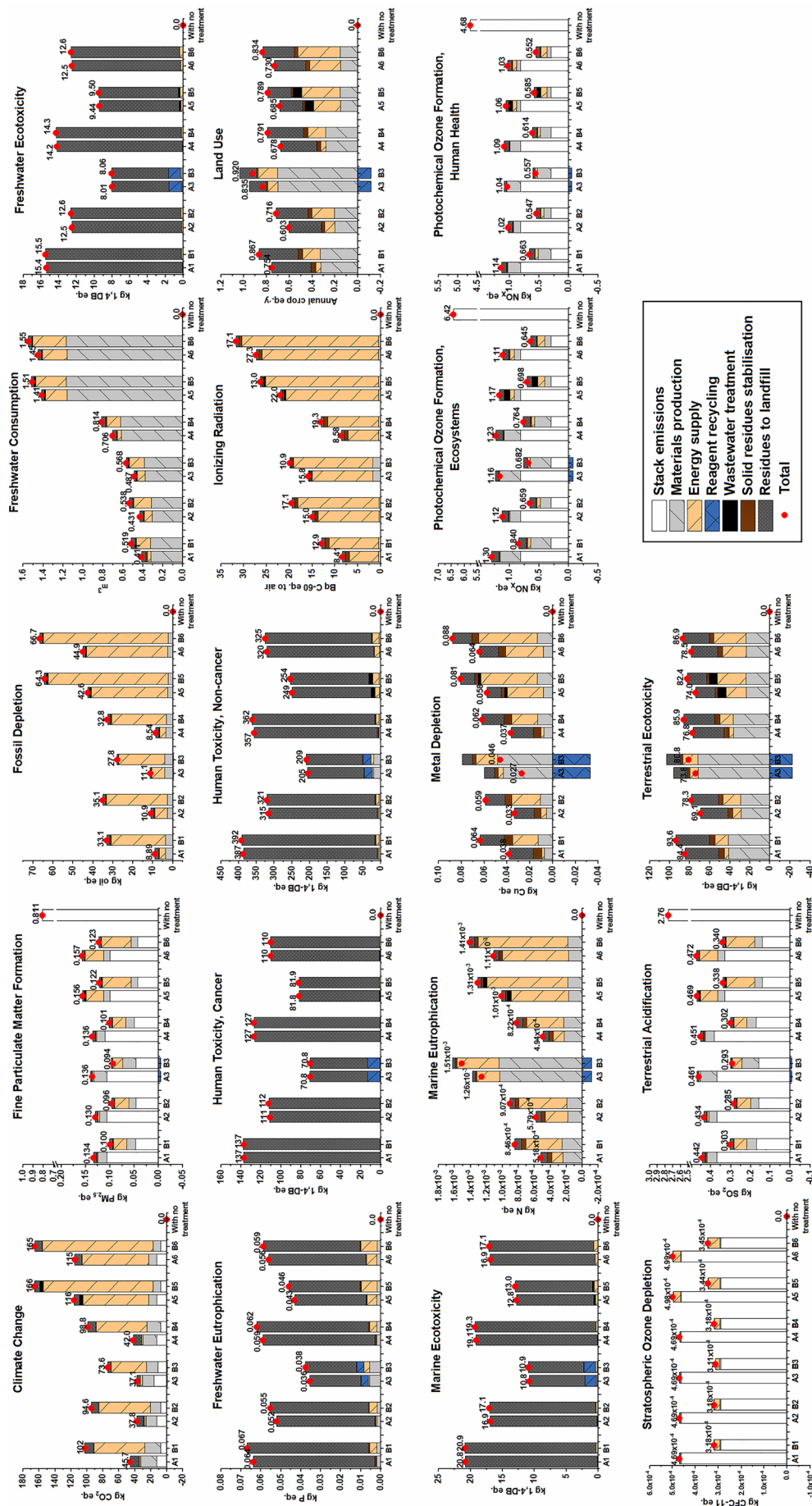

Fig. 3. Comparison of the environmental impacts of SNCR (A1-A6) and SCR (B1-B6) scenarios (All impacts expressed per tonne of the flue gas volume of 5250 Nm³/t MSW).

3.3. Impact assessment

GaBi v8.5 software is used for modelling the systems [49]. The latest version of ReCiPe 2016 v1.1 impact assessment method [50] has been applied to quantify the environmental impacts. All 18 midpoint impact categories included in ReCiPe are considered: climate change (CC), fine particulate matter formation (FPMF), fossil depletion (FD), freshwater consumption (FC), freshwater ecotoxicity (FEco), freshwater eutrophication (FE), human toxicity-cancer (HT-C), human toxicity-non-cancer (HT-N), ionizing radiation (IR), land use (LU), marine ecotoxicity (MEco), marine eutrophication (ME), metal depletion (MD), photochemical ozone formation-ecosystems (POF-E), photochemical ozone formation-human health (POF-HH), stratospheric ozone depletion (SOD), terrestrial acidification (TA) and terrestrial ecotoxicity (TE).

4. Results and discussion

This section is structured as follows: first, the environmental impacts of SNCR and SCR scenarios are presented in Sections 4.1 and 4.2, respectively. This is followed by their comparison in Sections 4.3 and 4.4. Section 4.5 and Section 4.6 discuss the results of the sensitivity and uncertainty analyses. The results are then compared with other studies in Section 4.7 and, finally, improvement opportunities are presented in Section 4.8.

4.1. Environmental impacts of SNCR scenarios

The total environmental impacts of the six SNCR Scenarios (A1–A6) are shown in Fig. 3, also showing the contribution of different life cycle stages. Overall, the wet systems A5, A6 have much higher impacts for eight out of 18 impact categories (CC, FPMF, FD, FC, IR, MD, SOD and TA). This is mainly due to the use of additional energy for reheating the flue gas from 70 to 150 °C, to avoid the visible plume from the stack. The reheating of the flue gas accounts for 71–73%, 90–91% and 93–94% of the total CC, FD and IR impacts in scenarios A5 and A6. Despite the lowest concentration of acid gases in stack emissions, such as SO₂ (Table 2), the overall TA for these scenarios is higher than for the others due to the additional impact associated with the reheating.

A comparison between A5 and A6 reveals that A6 has 1–34% higher impacts for 15 categories. This is despite A6 being an evolution of A5 to avoid the treatment and discharge of wastewater. However, this in turn increases the quantity of solid residues, collected by the upstream fabric filter before the wet scrubbers, whose disposal increases the environmental loadings.

The lowest impacts are found for either the dry systems A2 or A3, using Ca(OH)₂ or NaHCO₃ respectively. The results also show that A2, which is the modified version of A1, outperforms A1 in 14 impact categories. The better performance of A2 can be ascribed to the recirculation of a part of the un-reacted sorbent, which also reduces the amount of solid residues to be disposed of. The latter has a potential to decrease some impacts significantly as landfilling of residues contributes > 90% to FEco, FE, HT-C, HT-N and MEco (Fig. 3). Similarly, in A3, the recovery of sodium salts is the main reason for its superior performance in eight impacts.

The impacts of the semi-dry scenario A4 are generally in between the dry and wet systems. These findings are in line with the nature of the semi-dry process. The mass of the reagent required in different FGT systems increases from dry to semi-dry to wet systems, which

subsequently determines the quantity of residues to be disposed of. FD and ME are the exceptions, which are the lowest in A4 due to its simple configuration that requires less electricity.

The main contributors to the impacts vary across the categories. For example, the stack emissions are the main contributor to FPMF, POF-E, POF-HH, SOD and TA, while energy consumption contributes to CC, FD, IR, ME and MD. NaHCO₃ production is the hotspot for LU, ME, MD and TE, particularly in A3. These can be reduced by recycling but this increases FEco, HT-C, HT-N and MEco due to the additional energy and materials used for sodium salts recovery.

4.2. Environmental impacts of SCR scenarios

The results in Fig. 3 reveal that among the SCR scenarios, B3 performs better than the others with the lowest impacts across 10 categories. This is predominately due to the decreased amount of energy required to reheat the flue gas. As mentioned in Section 3.2.1, the required temperature window for the use of NaHCO₃ as a neutralising reagent is higher than for Ca(OH)₂. This leads to a higher temperature of the flue gas in B3 (around 170 °C compared to 140 °C in other dry systems B1 and B2), thus avoiding the use of reheating energy and the associated environmental impacts.

The key environmental hotspots for the SCR scenarios are very similar to those for the SNCR scenarios. For this reason, a comprehensive comparison of the SNCR and SCR scenarios is essential and is detailed in the next section.

4.3. Comparison of SNCR and SCR scenarios

The comparison of the scenarios in Fig. 3 shows that shifting from SNCR to SCR would significantly decrease FPMF, POF-E, POF-HH, SOD and TA. This associated benefit can be attributed to the reduction in stack emissions. Specifically, the SCR systems allow a more efficient NO_x removal (84% vs. 56% in SNCR), while also achieving a higher destruction of dioxins (34 vs 48 ng/t MSW in SNCR). However, due to the additional reheating of the flue gas, most other impacts are higher for the SCR than for SNCR systems. For example, the SCR systems have 49–284% greater CC and 43–150% higher FD than their SNCR counterparts.

Considering the individual scenarios and assuming equal importance of all impacts, A3 can be considered environmentally the most sustainable scenario, outperforming all other systems in seven out of 18 impact categories (Table 6). This includes CC which is estimated at 37.1 vs 73.6 kg CO₂ eq./t MSW found for its SCR counterpart B3. This is due to the SNCR and dry neutralisation of acid gases with NaHCO₃, which has two major advantages: (1) the possibility to recycle the used reagent; and (2) the avoidance of the need for flue gas reheating. In contrast, B1 is the least sustainable alternative for six impacts, due to a high consumption of the reagent (Ca(OH)₂) as well as the reheating of flue gas. B6 shows the highest environmental loadings in five impacts, while its counterpart A6 is the worst option for three impacts. For both the A6 and B6 Scenarios the higher impacts are largely due to a substantial amount of energy used for reheating.

It can also be observed in Table 6 that A2 and B2 each have the lowest impacts for two categories. This is mainly due to the recirculation of reagent which lowers its consumption. Similarly, B3 ranks the first in two impact categories due to a higher operating temperature of the NaHCO₃ reagent which decreases the reheating requirement in the downstream SCR.

Table 6

Comparison of the SNCR and SCR scenarios based on the number of highest and lowest impacts.

Basis	A1	B1	A2	B2	A3	B3	A4	B4	A5	B5	A6	B6
Number of impacts for which a scenario is the best option	2	–	2	2	7	2	2	–	–	–	–	1
Number of impacts for which a scenario is the worst option	2	6	–	–	–	2	–	–	–	–	3	5

4.4. Comparison with no treatment of flue gas

To put these results in context, Fig. 3 also compares the SNCR and SCR scenarios with a hypothetical option of not treating the flue gas at all. The concentrations of pollutants in the raw flue gas (Table 1) are assumed as the stack emissions in this option. The results show that, compared to the untreated flue gas, 81–88% of FPMF, 80–90% of POF-E, 76–88% of POF-HH and 83–90% of TA can be saved by treating the flue gas. This clearly indicates that all FGT systems considered in this study are effective in reducing impacts related to the pollutants targeted by legislation. However, 14 other impacts are generated that would not be otherwise if the flue gas was not treated. These include climate change, resource depletion and human and ecotoxicities, related to the use of energy and materials as well as wastewater and solid waste treatment. Therefore, this is the environmental cost, or penalty, of flue gas treatment which is not considered by legislation or policy but can clearly lead to significant unintended consequences. Such trade-offs should be understood much better and incorporated into future policies related to flue gas treatment from MSW incineration, but also from other systems, such as coal power and industrial plants.

4.5. Sensitivity analysis

As mentioned previously, the sensitivity analysis is based on a perturbation method used to identify key input parameters with high influence on the impacts. The results indicate that impacts are sensitive to four parameters: NO_x emissions and consumption of reagents, heat and electricity. As an illustration, Fig. 4 presents the SR values for selected impacts for the A3 and B3 Scenarios; for the remaining scenarios and impacts, see Tables S3–S8 in the SM. A higher SR value means that a variation in an input parameter would cause a larger relative variation in an impact.

It can be seen in Fig. 4 that the consumption of NaHCO₃ influences the largest number of impacts for both scenarios. The use of heat, which is only required in B3, affects CC, FD and TA. Some parameters only affect one impact and have a moderate SR. This is the case, for example, for the consumption of activated carbon which has a small effect on CC (SR ~ 0.1) and liquid ammonia which has a moderate influence on TE (SR ~ 0.2). The results in Tables S3–S8 also show that the SR values for

different scenarios are generally < 1, except for heat use in wet scenarios (A5, B5, A6 and B6), where the SR ranges from 2.75 to 9.96. This is due to a higher amount of heat required in the wet systems, which is also the major contributor to several impacts in these scenarios (see Fig. 3). For this reason, the next section explores how the recovery of heat from flue gases in wet systems may affect their performance.

4.5.1. Recovery of flue gas energy in wet systems

It has been reported that in some plants, such as Rennes France and AVI Netherlands [33], the temperature of flue gas at the boiler outlet could be reduced to 130–140 °C, thus allowing recovery of heat which could be used elsewhere. This is particularly feasible in wet FGT systems, because the wet scrubber does not require a minimum inlet working temperature and the extracted heat could be supplied subsequently to reheat the cooled flue gas for plume suppression and/or for SCR operation [26]. Such process is considered in the B5 scenario as an illustration, by assuming an additional heat exchanger to reduce the flue gas temperature from 180 to 140 °C before it enters the ESP. This new scenario is named “B5 + energy recovery” and its impacts are shown in Fig. S1.

It is not surprising that all the impacts are lower for this option than for the baseline B5 scenario. The highest reductions in impacts are observed for CC (16.3%), FD (15.6%) and MD (10.4%), as they are mostly related to the provision of energy (from natural gas). However, compared to dry and semi-dry systems (B1–B4), the B5 + energy recovery scenario still has higher impacts for eight categories (CC, FPMF, FD, FC, IR, MD, SOD and TA).

The energy recovery would also lower the water consumption of the wet scrubber, as a result of the lower temperature at the scrubber inlet and improve the overall plant energy efficiency [51]. However, there is an increased risk of corrosion as lower temperatures are close to the dew point of acid gases.

4.6. Uncertainty analysis

The parameters considered in the uncertainty analysis are stack emissions (PM, HCl, SO₂, dioxins, NO_x and NH₃) and consumption of reagents (Ca(OH)₂, NaHCO₃, activated carbon and liquid ammonia). They are varied between their minimum and maximum values (Tables 2

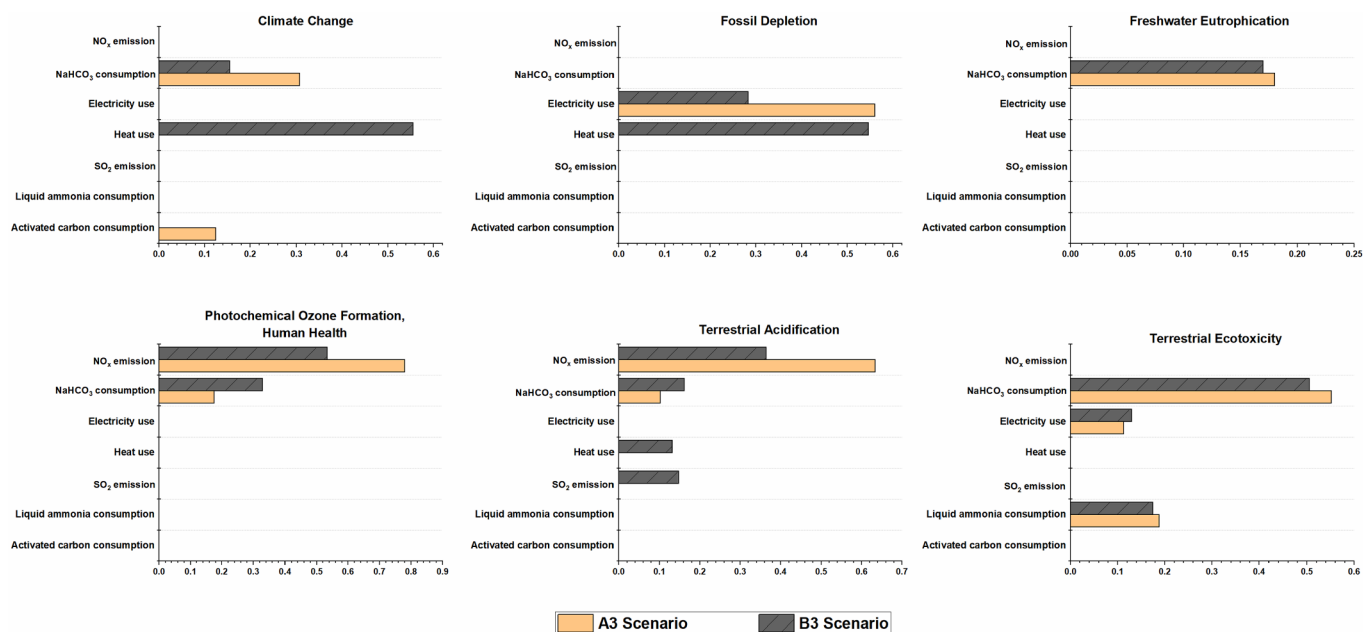

Fig. 4. Sensitivity analysis for input parameters in the A3 and B3 scenarios (Values represent sensitivity ratios (SR) estimated according to Eq. (1). Only SR > 0.1 are presented.)

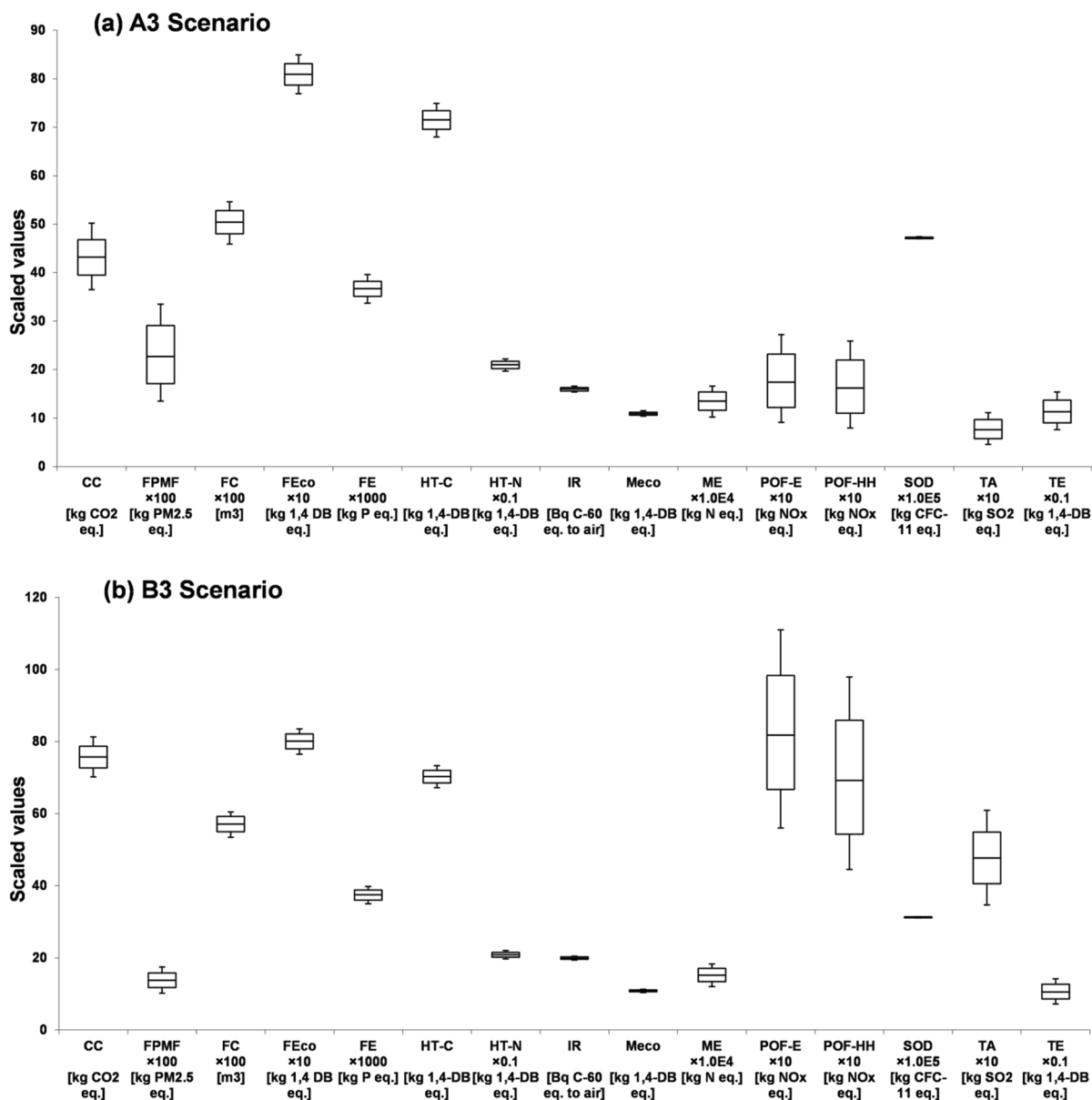

Fig. 5. Uncertainty analysis for input parameters in the A3 and B3 scenarios (All impacts are expressed per tonne of MSW. The box plots represent the interquartile ranges and the whisker bars are 10% and 90% percentiles. Some impacts are scaled to fit the y-axis; their original values can be obtained by multiplying with the factor shown on the x-axis.)

and 3) through Monte Carlo simulations. The results are given in Fig. 5, again using scenarios A3 and B3 as an illustration. It can be noted that the variation in some of the environmental impacts is large, including POF-HH, POF-E, FPMP, TA, TE and ME. In both scenarios, these impacts have standard deviations > 15%. For example, POF-HH in A3 ranges from 0.795 to 2.59 kg NO_x eq./t MSW with a standard deviation of 39.5%, while for B3 scenario, the range is 0.445–0.979 kg NO_x eq./t MSW with a 27.9% standard deviation. These variations in the impacts can be explained through the contribution and sensitivity analyses as follows:

- POF-HH, POF-E, FPMP and TA: stack emissions have high contribution to these impacts, mostly due to the differences in plant-specific performance, particularly for NO_x abatement.
- TE and ME: reagent consumption is the major cause of the high variations in these categories.

4.7. Comparison of results with other studies

As mentioned in the introduction, only limited LCA studies of different FGT systems are available. Their comparison is difficult due to the variation in FGT technologies and target pollutants, functional units, system boundaries and impact assessment methods. Nevertheless, an attempt is made here to compare the relative environmental sustainability of different FGT technologies with some of the existing studies.

For the reduction of acid gases, Dal Pozzo et al. [19] and Scipioni et al. [26] reported that dry scrubbers had lower environmental impacts than the wet counterpart. The energy used for flue gas reheating was the main drawback of the wet scrubber, while the main contributor to the impacts of the dry system was the production of reagents. These findings are in good agreement with the current study.

Dal Pozzo et al. [52] analysed the effects of NaHCO₃ recycling in a dry system by installing an upstream fabric filter. The results showed a positive role of reagent recycling in reducing the total environmental

impacts, which is well aligned with the current study. The authors, as well as Turconi et al. [53], found that the production of NaHCO_3 was the main contributor to acidification, which was higher than the contribution of stack emissions. The results obtained in this study also identify NaHCO_3 production as the main source of indirect terrestrial acidification; however, the contribution of stack emissions to the total life cycle TA is more significant. This can be attributed to the variation in the target pollutants and their concentrations in the two studies.

For the reduction of NO_x emissions, several existing studies [15,54] reported that SNCR was preferred over SCR. This is due the much higher indirect impacts of the latter resulting from reheating of the flue gas. Van Caneghem et al. [15] found that, compared with SNCR, SCR could only reduce acidification, eutrophication and photochemical ozone formation (using the CML impact assessment method), while increasing other impacts. These results accord well with the current study, as only four out of 18 impacts are decreased by SCR, including terrestrial acidification and ozone formation. However, Liang et al. [24] reported in contrast that SCR was environmentally a better option than SNCR. These different findings are mainly due to the differences in the system boundaries between the studies.

4.8. Improvement opportunities

Based on the above analyses, the wet systems, with either SNCR or SCR, are not recommended on environmental grounds. Despite their high removal efficiency for acid gases, the indirect environmental impacts are higher than in the dry systems due to the requirement for reheating the flue gas. This is probably the reason that an increasing number of plants have decided to convert the wet system into a dry or semi-dry [26,55]. However, for plants where this modification is not feasible, the focus should be on reducing energy consumption, for example, by recovering some of the flue gas energy via a heat exchanger upstream of the scrubber, and/or, using the heat from the SCR exhaust to heat up its inlet [33]. Another possibility is to recover energy at the boiler outlet as discussed in Section 4.5.1.

The results also suggest that dry systems with reagent recycling (A2, B2, A3, B3) and semi-dry systems (A4, B4) have lower impacts than dry systems with no reagent recycling (A1 and B1). The main reason for this is the increased requirement for the reagent, as the stoichiometric ratio for dry systems is much higher than that in semi-dry and wet systems, thus resulting in increased quantity of residues to be disposed of. Thus, recirculating the residues, which still contain a large quantity of unused reagent, back to the flue gas stream is an effective improvement opportunity. This requires an additional de-dusting unit for the preliminary separation of fly ash. However, with very low investment and maintenance costs, it is very attractive for industrial use. The reagent recirculation is also feasible in dry NaHCO_3 -based systems. Furthermore, in such systems, recovery of the residual sodium salts for brine production (e.g. via the NEUTREC process) is also possible, further reducing the environmental impacts.

Shifting from SNCR to SCR allows for a more efficient removal of NO_x due to the presence of a catalyst. However, this benefit is offset by the higher energy consumption for reheating the flue gas, which results in much higher CC, FD, FC, FE, IR, LU, ME, MD and TE (see Fig. 3). Some MSW plants use a “high-dust” SCR located directly after the boiler to avoid the need for reheating the flue gas. However, a major concern related to such systems is catalyst degradation as a high-dust loading increases the risk of its poisoning and clogging [56]. At the same time, the lifetime of catalyst can be expected to be shortened as a result of the higher operating temperatures.

The use of NaHCO_3 in a dry system is more favourable for a tail-end SCR. The outlet of the scrubber in this configuration could benefit from a higher temperature, thus minimising the need for reheating, while simultaneously achieving higher NO_x reductions.

Optimising SNCR is another practical and economically attractive improvement option for use in existing MSW plants. As indicated by De Greef et al. [57], the operation of SNCR is often not well tuned with

respect to the conditions of ammonia injection, mixing or mass transfer. These can be further optimised for a higher NO_x removal.

Finally, the effect of different FGT systems on energy efficiency of the incineration plants should also be taken into account when selecting an appropriate design of the treatment systems. For example, it is estimated that using SCR instead of SNCR would decrease the plant net power output by 3–6%, while reducing the flue gas temperature at the boiler outlet from 180 to 140 °C has the potential to increase the overall energy recovery by approximately 1.6–2.8% [33]. Moreover, it is also necessary to consider the economic implications of these improvements.

5. Conclusions

This work has estimated life cycle environmental impacts of 12 systems for treating flue gas from MSW incinerators. The systems represent various combination of technologies for the removal of particulate matter, acid gases, nitrogen oxides, dioxins and heavy metals and are representative of the FGT technologies used around the world.

The results show that the wet systems have higher environmental impacts than the dry alternatives, mainly due to the substantial amount of energy required for flue gas reheating in SNCR systems or for catalyst operation in the SCR counterparts. A dry system with non-recycled $\text{Ca}(\text{OH})_2$ exhibits higher impacts than a system which reuses the reagent, as a result of its overdosing and the increased disposal of residues. The semi-dry systems generally have impacts in between the dry and wet ones. Compared to SNCR, the use of SCR decreases the NO_x related impacts (terrestrial acidification and photochemical ozone formation-human health) but increases the other impacts, including climate change and fossil depletion, due to the need to reheat the flue gas. Overall, SNCR + NaHCO_3 dry system (scenario A3) represents environmentally the most sustainable option for seven impacts across all the alternatives considered. By contrast, SCR + $\text{Ca}(\text{OH})_2$ dry system (scenario B1) is the least sustainable alternative for six impacts due to a high consumption of the reagent and the reheating of flue gas.

The key contributors to the environmental impacts are consumption of reagents (NaHCO_3 , $\text{Ca}(\text{OH})_2$), heat and electricity as well as NO_x emissions. Based on these, the improvements should focus on more efficient use of energy, particularly in wet SCR systems, and optimisation of SNCR and SCR operating parameters.

The results also demonstrate that, while the flue gas treatment reduces significantly the formation of fine particulates (81–88%), photochemical smog (76–90%) and terrestrial acidification (83–90%), it also creates 14 other impacts that would not have been generated if the flue gas was left untreated. Therefore, future policy and legislation should consider these trade-offs carefully to minimise the unintended consequences of flue gas treatment from incineration and other plants.

CRedit authorship contribution statement

Jun Dong: Investigation, Data curation, Writing - original draft.
Harish Kumar Jeswani: Software, Validation, Writing - review & editing.
Ange Nzihou: Conceptualization, Supervision, Funding acquisition.
Adisa Azapagic: Methodology, Resources, Writing - review & editing.

Declaration of Competing Interest

The authors declare that they have no known competing financial interests or personal relationships that could have appeared to influence the work reported in this paper.

Acknowledgments

This project is supported by the French Centre National de la Recherche Scientifique (CNRS), the Labex SOLSTICE (Agence Nationale de la Recherche, ANR) and the UK Engineering and Physical Sciences

Research Council (EPSRC, Gr. no. EP/K011820/1). Jun Dong also acknowledges the Sustainable Industrial Systems at The University of Manchester for hosting her study visit during which this work was carried out.

Appendix A. Supplementary material

Supplementary data to this article can be found online at <https://doi.org/10.1016/j.apenergy.2020.114792>.

References

- Arena U. From waste-to-energy to waste-to-resources: the new role of thermal treatments of solid waste in the Recycling Society. *Waste Manage* 2015;37:1–3.
- Di Maria F, Sisani F, Contini S. Are EU waste-to-energy technologies effective for exploiting the energy in bio-waste? *Appl Energy* 2018;230:1557–72.
- European Commission. Eurostat data on Municipal waste by waste management operations; 2017. Available at: http://appsso.eurostat.ec.europa.eu/nui/show.do?dataset=env_wasmun.
- ADEME. Déchets Chiffres-clés - Edition 2016. Angers, France; 2016.
- Ayodele TR, Ogunjuyigbe ASO, Alao MA. Life cycle assessment of waste-to-energy (WtE) technologies for electricity generation using municipal solid waste in Nigeria. *Appl Energy* 2017;201:200–18.
- European Commission. Directive 2000/76/EC of the European Parliament and of the Council of 4 December 2000 on the incineration of waste. *Off J Eur Commun L* 2000;332:91–111.
- European Commission. Directive 2010/75/EU of the European Parliament and of the Council of 24 November 2010 on industrial emissions (Integrated Pollution Prevention and Control). *Off J Eur Union L* 2010;334:17–119.
- Vehlow J. Air pollution control systems in WtE units: An overview. *Waste Manage* 2015;37:58–74.
- Jiang K, Yu H, Chen L, Fang M, Azzi M, Cottrell A, et al. An advanced, ammonia-based combined NOx/SOx/CO2 emission control process towards a low-cost, clean coal technology. *Appl Energy* 2020;260:114316.
- Chen S, Kharrazi A, Liang S, Fath BD, Lenzen M, Yan J. Advanced approaches and applications of energy footprints toward the promotion of global sustainability. *Appl Energy* 2020;261:114415.
- Laurent A, Clavreul J, Bernstad A, Bakas I, Niero M, Gentil E, et al. Review of LCA studies of solid waste management systems—Part II: Methodological guidance for a better practice. *Waste Manage* 2014;34:589–606.
- Tong H, Shen Y, Zhang J, Wang C-H, Ge TS, Tong YW. A comparative life cycle assessment on four waste-to-energy scenarios for food waste generated in eateries. *Appl Energy* 2018;225:1143–57.
- Jeswani H, Azapagic A. Assessing the environmental sustainability of energy recovery from municipal solid waste in the UK. *Waste Manage* 2016;50:346–63.
- Astrup TF, Tonini D, Turconi R, Boldrin A. Life cycle assessment of thermal waste-to-energy technologies: review and recommendations. *Waste Manage* 2015;37:104–15.
- Van Caneghem J, De Greef J, Block C, Vandecasteele C. NOx reduction in waste incinerators by selective catalytic reduction (SCR) instead of selective non catalytic reduction (SNCR) compared from a life cycle perspective: a case study. *J Clean Prod* 2016;112:4452–60.
- Perazzini H, Freire FB, Freire JT. Thermal treatment of solid wastes using drying technologies: a review. *Dry Technol* 2016;34:39–52.
- Chevalier J, Rousseaux P, Benoit V, Benadda B. Environmental assessment of flue gas cleaning processes of municipal solid waste incinerators by means of the life cycle assessment approach. *Chem Eng Sci* 2003;58:2053–64.
- Wu X, Wu K, Zhang Y, Hong Q, Zheng C, Gao X, et al. Comparative life cycle assessment and economic analysis of typical flue-gas cleaning processes of coal-fired power plants in China. *J Clean Prod* 2017;142:3236–42.
- Dal Pozzo A, Guglielmi D, Antonioni G, Tugnoli A. Environmental and economic performance assessment of alternative acid gas removal technologies for waste-to-energy plants. *Sustain Prod Consum* 2018;16:202–15.
- Biganzoli L, Racanella G, Marras R, Rigamonti L. High temperature abatement of acid gases from waste incineration. Part II: Comparative life cycle assessment study. *Waste Manage* 2015;35:127–34.
- Feng C, Gao X, Tang Y, Zhang Y. Comparative life cycle environmental assessment of flue gas desulfurization technologies in China. *J Clean Prod* 2014;68:81–92.
- Xu R, Hou F. Integrating LCA and LCC study of FGD system at a thermal power plant in China. *Journal of Software* 2010;5:1425–32.
- Møller J, Munk B, Crillesen K, Christensen TH. Life cycle assessment of selective non-catalytic reduction (SNCR) of nitrous oxides in a full-scale municipal solid waste incinerator. *Waste Manage* 2011;31:1184–93.
- Liang Z, Ma X, Lin H, Tang Y. The energy consumption and environmental impacts of SCR technology in China. *Appl Energy* 2011;88:1120–9.
- Damgaard A, Riber C, Fruergaard T, Hulgaard T, Christensen TH. Life-cycle-assessment of the historical development of air pollution control and energy recovery in waste incineration. *Waste Manage* 2010;30:1244–50.
- Scipioni A, Mazzi A, Niero M, Boatto T. LCA to choose among alternative design solutions: the case study of a new Italian incineration line. *Waste Manage* 2009;29:2462–74.
- Wen Z, Di J, Liu S, Han J, Lee JCK. Evaluation of flue-gas treatment technologies for municipal waste incineration: A case study in Changzhou. *China J Clean Prod* 2018;184:912–20.
- Cui L, Li Y, Tang Y, Shi Y, Wang Q, Yuan X, et al. Integrated assessment of the environmental and economic effects of an ultra-clean flue gas treatment process in coal-fired power plant. *J Clean Prod* 2018;199:359–68.
- ISO. ISO 14040: Environmental management—life cycle assessment—principles and framework, 2nd ed. Geneva: ISO; 2006.
- ISO. ISO 14044: Environmental Management—Life Cycle Assessment—Requirements and Guidelines: ISO; 2006.
- Finnveden G, Hauschild MZ, Ekvall T, Guinée J, Heijungs R, Hellweg S, et al. Recent developments in life cycle assessment. *J Environ Manage* 2009;91:1–21.
- Parra D, Zhang X, Bauer C, Patel MK. An integrated techno-economic and life cycle environmental assessment of power-to-gas systems. *Appl Energy* 2017;193:440–54.
- European Commission. Integrated Pollution Prevention and Control Reference Document on the Best Available Techniques for Waste Incineration. Brussels; 2006.
- Jurczyk M, Mikus M, Dziedzic K. Flue gas cleaning in municipal Waste-to-Energy plants-Part 2. *Infrastruktura i Ekologia Terenów Wiejskich*; 2016.
- Beylot A, Hochar A, Michel P, Descat M, Ménard Y, Villeneuve J. Municipal solid waste incineration in France: an overview of air pollution control techniques, emissions, and energy efficiency. *J Ind Ecol*. 2017. <https://doi.org/10.1111/jiec.12701>.
- Makarichi L, Jutidamrongphan W, Techato K-a. The evolution of waste-to-energy incineration: A review. *Renew Sust Energ Rev* 2018;91:812–21.
- International Ash Working Group. An international perspective on characterisation and management of residues from municipal waste incineration. Great Britain: Elsevier Science Ltd; 1995.
- Beylot A, Muller S, Descat M, Ménard Y, Michel P, Villeneuve J. WILCI: a LCA tool dedicated to MSW incineration in France. In 16th Waste management and landfill symposium Sardinia symposium; 2017.
- Beylot A, Villeneuve J. Environmental impacts of residual Municipal Solid Waste incineration: A comparison of 110 French incinerators using a life cycle approach. *Waste Manage* 2013;33:2781–8.
- Bisinella V, Götze R, Conradsen K, Damgaard A, Christensen TH, Astrup TF. Importance of waste composition for Life Cycle Assessment of waste management solutions. *J Clean Prod* 2017;164:1180–91.
- Fruergaard T, Astrup T. Optimal utilization of waste-to-energy in a LCA perspective. *Waste Manage* 2011;31:572–82.
- Doka G. Updates to Life Cycle Inventories of Waste Treatment Services - Part II "Waste incineration". Zürich, Switzerland: Doka Life Cycle Assessments; 2013.
- Locci C, Vervisch L, Farcy B, Domingo P, Perret N. Selective Non-Catalytic Reduction (SNCR) of nitrogen oxide emissions: A perspective from numerical modeling. *Flow, Turb Combust* 2018;100:301–40.
- Li J, Chang H, Ma L, Hao J, Yang RT. Low-temperature selective catalytic reduction of NOx with NH3 over metal oxide and zeolite catalysts—A review. *Catal Today* 2011;175:147–56.
- Ecoinvent. Life Cycle Inventory Data Version 3.3. Zurich, Switzerland; 2016. < <https://www.ecoinvent.org> > .
- Pacher C, Weber-Blaschke G, Mocker M, Quicker P. Comparative ecological examination of different types of feedstock in dry sorbent injection processes for flue gas treatment (in German) Final Report for the Federation of German Lime Industry Technische Universität München-ATZ Entwicklungszentrum; 2009.
- Bodík I, Kubaska M. Energy and sustainability of operation of a wastewater treatment plant. *Environ Prot Eng* 2013;39:15–24.
- Fruergaard T, Hyks J, Astrup T. Life-cycle assessment of selected management options for air pollution control residues from waste incineration. *Sci Total Environ* 2010;408:4672–80.
- Thinkstep. GaBi Software System and database for Life Cycle Engineering 1992–2018. Germany: Leinfelden-Echterdingen; 2018.
- Huijbregts M, Steinmann Z, Elshout P, Stam G, Verones F, Vieira M, et al. ReCiPe 2016 v1.1 - A harmonized life cycle impact assessment method at midpoint and endpoint level; Report I: Characterization. Bilthoven, The Netherlands: National Institute for Public Health and the Environment; 2017.
- Grieco E, Poggio A. Simulation of the influence of flue gas cleaning system on the energetic efficiency of a waste-to-energy plant. *Appl Energy* 2009;86:1517–23.
- Dal Pozzo A, Guglielmi D, Antonioni G, Tugnoli A. Sustainability analysis of dry treatment technologies for acid gas removal in waste-to-energy plants. *J Clean Prod* 2017;162:1061–74.
- Turconi R, Butera S, Boldrin A, Grosso M, Rigamonti L, Astrup T. Life cycle assessment of waste incineration in Denmark and Italy using two LCA models. *Waste Manage Res* 2011;29(Supplement):78–90.
- Beckmann M, Gampe U, Grahl S, Hellfrisch S. Zielkonflikt Emissionen und Energieeffizienz am Beispiel der 37. BImSchV. In Thomé-Kozmiensky KJ, Beckmann M, editors. *Energie aus Abfall*. Neuruppin: TK Verlag; 2009, p. 3–32.
- Löschau M, Karpf R. Flue Gas Treatment—State of the Art. 12-13th October 2015, Vienna: IRRC – Waste-to-Energy; 2015.
- Roy S, Hegde MS, Madras G. Catalysis for NOx abatement. *Appl Energy* 2009;86:2283–97.
- De Greef J, Villani G, Goethals J, Van Belle H, Van Caneghem J, Vandecasteele C. Optimising energy recovery and use of chemicals, resources and materials in modern waste-to-energy plants. *Waste Manage* 2013;33:2416–24.