



**HAL**  
open science

## Measurement and Calculation of Preform Infrared Heating a first approach

Yannick Le Maout, Fabrice Schmidt, V Laborde, Mouna El-Hafi, Philippe Lebaudy

► **To cite this version:**

Yannick Le Maout, Fabrice Schmidt, V Laborde, Mouna El-Hafi, Philippe Lebaudy. Measurement and Calculation of Preform Infrared Heating a first approach. 4th International Workshop on Advanced Infrared Technology and Applications, Sep 1997, Florence, Italy. hal-02056160

**HAL Id: hal-02056160**

**<https://imt-mines-albi.hal.science/hal-02056160>**

Submitted on 14 Mar 2019

**HAL** is a multi-disciplinary open access archive for the deposit and dissemination of scientific research documents, whether they are published or not. The documents may come from teaching and research institutions in France or abroad, or from public or private research centers.

L'archive ouverte pluridisciplinaire **HAL**, est destinée au dépôt et à la diffusion de documents scientifiques de niveau recherche, publiés ou non, émanant des établissements d'enseignement et de recherche français ou étrangers, des laboratoires publics ou privés.

## MEASUREMENT AND CALCULATION OF PREFORM INFRARED HEATING : A FIRST APPROACH

Y. LE MAOULT (\*), F. M. SCHMIDT (\*),  
V. LABORDE (\*), M. EL HAFI (\*), P. LEBAUDY (\*\*),

### Abstract

In a first step, the goal of the work is to obtain an accurate characterisation of the heat source of the infrared emitter. In a second step, the computation of the view factor between the lamp and the preform has been performed using a Monte-Carlo method. Then, an experimental validation of the view factor computation using quantitative infrared thermography has been developed. This work is a first contribution to the study of radiative heat transfer which are involved in infrared heating of preform related to the injection stretch-blow molding of thermoplastic bottles.

### Nomenclature

Bi	Biot number	$\alpha$	total Absorptivity of a sheet
$c_p$	Specific Heat of copper	$\varepsilon_t$	Emissivity of tungsten
$F_{12}$	View factor	$\lambda$	Wavelength
I	Intensity of the current	$\phi$	Heat flux
m	mass of a sheet	$\rho$	Resistivity of tungsten
$N_t$	Total generation of random numbers	$\rho_c$	Density of copper
R	Resistance	$\sigma$	Variance
S	Surface of a sheet	$\tau$	Thermal time constant
T	Temperature	k	thermal conductivity of copper
U	Supply of a lamp	h	global heat transfer coefficient
V	Volum of a sheet		

---

(\*) ÉCOLE DES MINES d'ALBI, Campus universitaire Jarlard, Route de Teillet, 81013 ALBI CT CEDEX 09 (FRANCE)

(\*\*) UNIVERSITE DE ROUEN, LECAP, 76812 MONT-SAINT-AIGNAN CEDEX (FRANCE)

## 1. Introduction

Forming processes of thermoplastic such as PET, PVC or PP (injection stretch-blow molding, thermoforming,...) need a heating stage [1, 2]. A tube-shaped or sheet-shaped preform is heated in an infrared oven above the glass transition temperature (for PET  $T_g \approx 80\text{ }^\circ\text{C}$ ) in order to provide a rubber-like state before the inflation step. The optimisation of the heating stage is crucial. The final thickness distribution of the product is drastically controlled by the initial temperature distribution inside the preform. Besides, the optimisation of the oven will permit to minimise the cost of energy. So the preliminary work presented here deals with two particular points :

- The characterization of the infrared lamp used to heat the preform (temperature, spectral, and directionnal aspects)
- The interaction between the lamp and the preform (view factor), this last point is not obvious when the emission of the lamp is strongly directionnal and when the radiant energy interact with a semi-transparent media [3].

A typical oven with blowing process is shown in figure 1

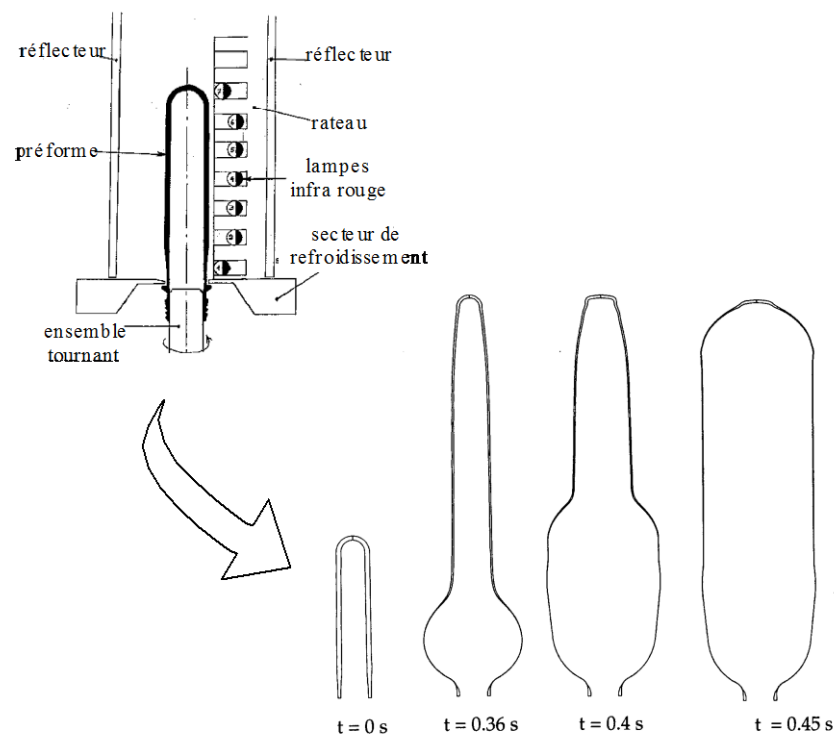

figure 1

## 2. Characterization of the heat source : the infrared emitter

### 2.1 physical description of the lamp

we used a philips lamp which is commonly plugged in industrial ovens. The nominal power of this source is 300 W. The different components of this lamp are :

- a specific double spiraled filament contained in a tubular enclosure in quartz.
- A reflector (polished aluminium) fitted on the back side of the quartz, its main role is to increase the efficiency of the emitter in the forward direction.

A view of the lamp is shown in figure 2 :

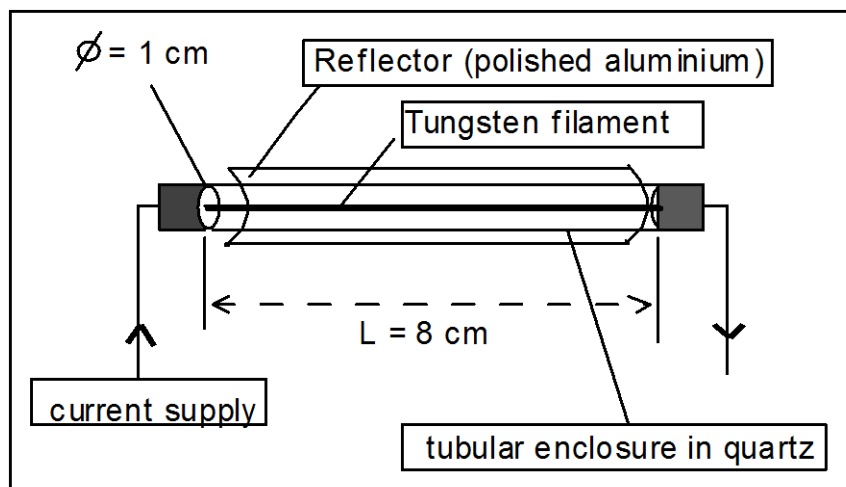

figure 2

### 2.2 Temperature of the tungsten filament.

An electrical setup has been realized to make temperature measurement of the filament. A variation of the supply  $U$  of the lamp is necessary to plot a curve of  $U$  versus  $I$  (amp), this graph is easily converted to a list of value of the resistivity  $\rho(T)$  from a well-known relationship

$$R(T) = \rho(T) \cdot \frac{L(T)}{S(T)} \quad (1)$$

Where  $L$  and  $S$  are the length and the cross section respectively. The variation of the term  $L/S$  versus  $T$  is very weak compared to  $\rho(T)$  and can be assumed as a constant, then an inverse polynomial interpolation based on the dataset of  $r$  from [4] give  $T = f(\rho)$  with  $T$  in Kelvins :

$$T = -5.723e^{-2}\rho^2 + 36.58\rho + 115.3 \quad (2)$$

at nominal Power ( $P=300$  W), we find :  $T = 2030 \pm 50^\circ\text{C}$

This approach has been also validated with an optical pyrometer. The absolute uncertainty of  $50^\circ\text{C}$  is not a determinant factor because of a weak variation of emissivity between  $2000$  and  $2100^\circ\text{C}$ .

### 2.3 Spectral emissivity

In order to modelize the spectral intensity emitted by this kind of lamp, we have to know accurately the spectral emissivity of the tungsten wire and the transmittivity of the quartz tube. This can be done by using spectral data of tungsten [5]. Unfortunately, to fit a complete spectra at the right temperature, (beyond  $2.5 \mu\text{m}$ ), it was necessary to use the Drude approach which is based on electromagnetic theory. The particular expression of this model is :

$$\varepsilon(\lambda, T) = 36.5 \left( \frac{\rho(T)}{\lambda} \right)^{0.5} - 464 \frac{\rho(T)}{\lambda} \quad (3)$$

This relation becomes acceptable when the wavelength  $> 3 \mu\text{m}$ . The figure 3 shows the the compilation of different characteristics, especially intensity including the effect of the quartz window :

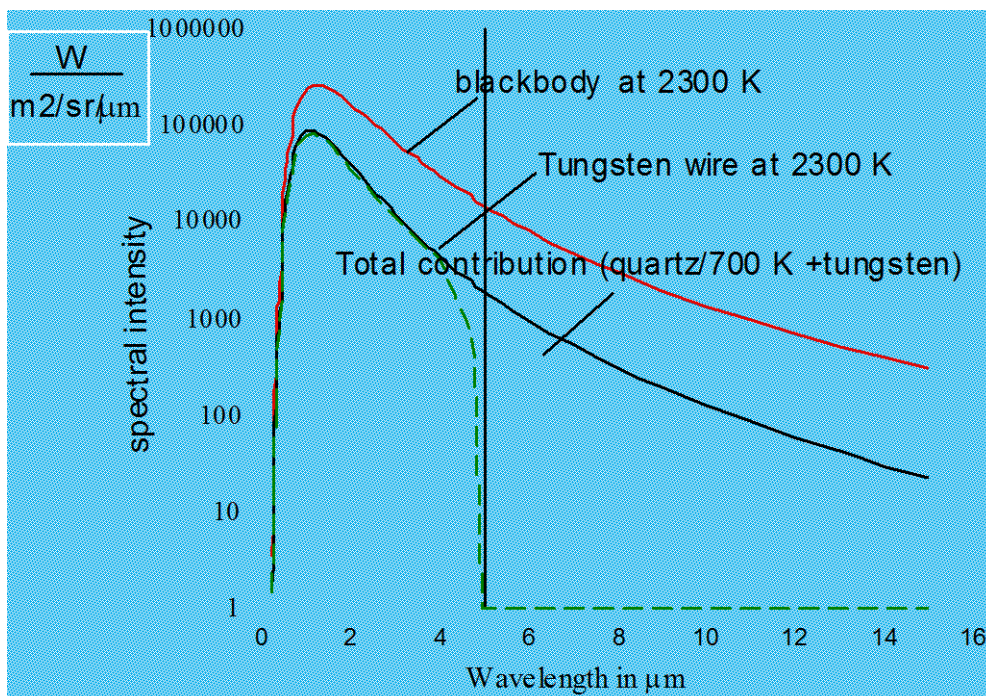

figure 3

### 2.3 Directional emission

A very important point in oven design : an IR source with a very strong directionality will produce overheating (hotpoints) on the preform (we have to keep in mind that polymers have a very low thermal conductivity, a typical value is  $\approx 0.2 \text{ W/m.K}$ ). Another specific experimental setup has been used to study this problem : a Si(IR) sensor (photodiode) describes a half circle around the lamp and give the integrated intensity for several directions. The spectral responsivity of such optical component is limited to the spectral domain 750 to 1100 nm. The results are presented on figure 4 for different cases. It appears that the reproducibility of the spatial distribution of intensity is affected after reassembling the reflector.

This point highlights the fact that an optical optimization is necessary to heat properly a product:

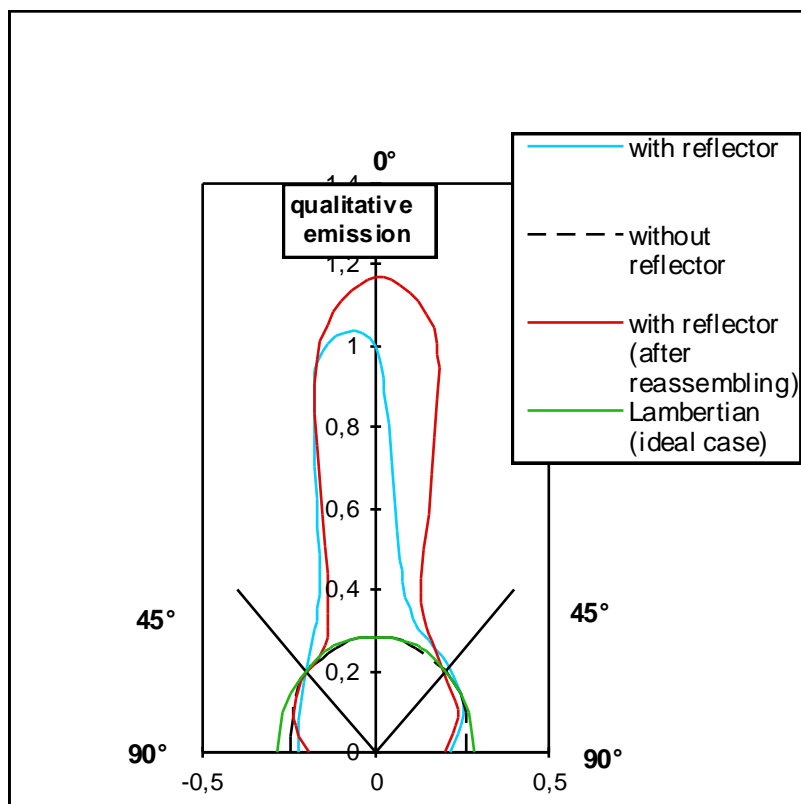

figure 4

### 3. Interaction between the lamp and the preform : Computation of the view factor (first approach : lambertian case)

3.1 Assumptions : the surfaces are gray and uniform. These surfaces are considered as diffuse emitters and the geometrical configurations are simple (rectangular sheets) as shown below (figure 5) :

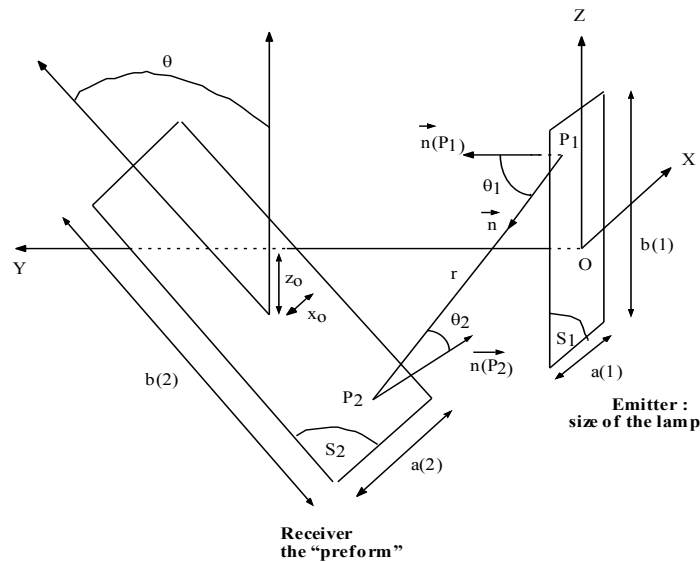

figure 5

The knowledge of the view factor  $F_{12}$  (dimensionless parameter) is a fundamental point in radiative transfer to compute the thermal power absorbed by the receiver (2) from the emitter (1); so we have :

$$\Phi_{\text{abs}} = F_{12} \alpha \Phi_{\text{emis}} \quad (4)$$

bibliographic search [6 / 7] shows that, except for simple cases where analytical solutions are available, most configurations must be treated with numerical methods. As we show, the Monte Carlo method has been chosen for this test compared to Nusselt's sphere results. The principle of Monte Carlo method is based on statistical approach applied to integral calculation. A generation of random numbers is performed according to a particular distribution function. The implementation runs on a various set of data and the program generates points belonging to the different surfaces (the distribution can be isotropic or not for each surfaces). At least the estimation of the error is made by variance calculation. The results are gathered in a table which presents a comparison with analytical solution if possible or another numerical methods. We tested the following sizes for the computation : Emitter : (8 cm \* 1 cm) / Receiver (3 cm \* 20 cm). At first, we have tested a non-centered configuration (Receiver shifted respect to the Emitter). The comparison with an analytical solutions shows that the relative error remains weaker than 2 %; but a more interesting case is the following : configuration where the receiver is inclined respect to the emitter (no analytical solution available):

$\theta$ (°)	$x_0$	$z_0$	d	$F_{12}$ Nusselt's sphere	$F_{12}$ Monte Carlo	rel. error in %
15	0	0	10	0,12034	0,12169	1,1
15	0	0	20	0,04017	0,04005	0,3
30	0	0	10	0,12677	0,12709	0,2
30	0	0	20	0,03918	0,03818	2,6
15	5	5	10	0,07455	0,06482	13
15	8	0	10	0,05043	0,04950	1,8
15	0	5	10	0,11802	0,09765	17,3

The number of elements for the emitter (Nusselt method) is  $150 * 150$  and  $Nt$  (statistical generations for Monte Carlo) is 3000 . The Agreement is good except in two cases where a hidden surface problem appears.

#### 4. Experimental validation of the view factor computation using quantitative infrared thermography.

4.1 Description of the experimental setup (figure 6) :

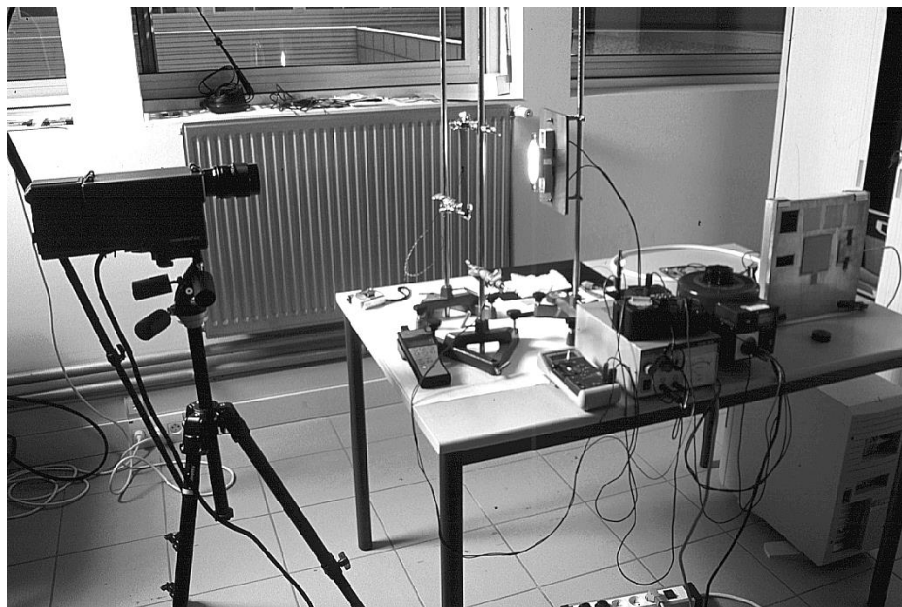

figure 6



The preform is represented here by a sheet of copper coated with a flat black painting (Emissivity = 0.92 between 0.5 and 20  $\mu\text{m}$ ) and the heater is assembled without reflector at nominal power. The camera used in this experiment is a 880 LW (8-12  $\mu\text{m}$  band) / AGEMA. The frequency of analysis is equal to 25 frames/ s and the device is plugged on a 12 bits data acquisition board drive by a real time software (PC AT).

#### 4.2 Simplified model of heat transfer in the copper sheet

Experimental procedure : the camera observes the back face of the copper sheet which has been screened from the radiant source with a polished aluminium plate. The screen is suddenly removed (Heaviside step of flux on the sheet) and the temperature evolution of the sheet is plotted up to the steady state. We made the assumption (which is validated at the end) that the heat transfer in the sheet can be treated as a lump capacitance model (transient aspect) so Bi must be  $< 0.1$ . The averaging equation is :

$$\rho_c V c_p \frac{dT}{dt} + 2h_g S(T - T_a) = \Phi_{\text{abs}} \quad (5) \text{ and } \phi_{\text{abs}} \text{ is deduced from (4)}$$

The power emitted by the lamp is known by the electrical measurements of U, I so for the steady state  $P_{\text{elec}} = \Phi_{\text{emis.}} = U.I$ , the solution of (5) is

$$T = T_a + \frac{\phi_{\text{abs}}}{2 h_g S} \left( 1 - e^{-\frac{t}{\tau}} \right) \quad (6)$$

$\tau$  the time constant of a sheet is equal to  $mc_p / 2hg.S$  and  $T_a$  the initial temperature is equal to the ambient temperature. The temperature evolution of the sheet is plotted hereafter (figure 7) :

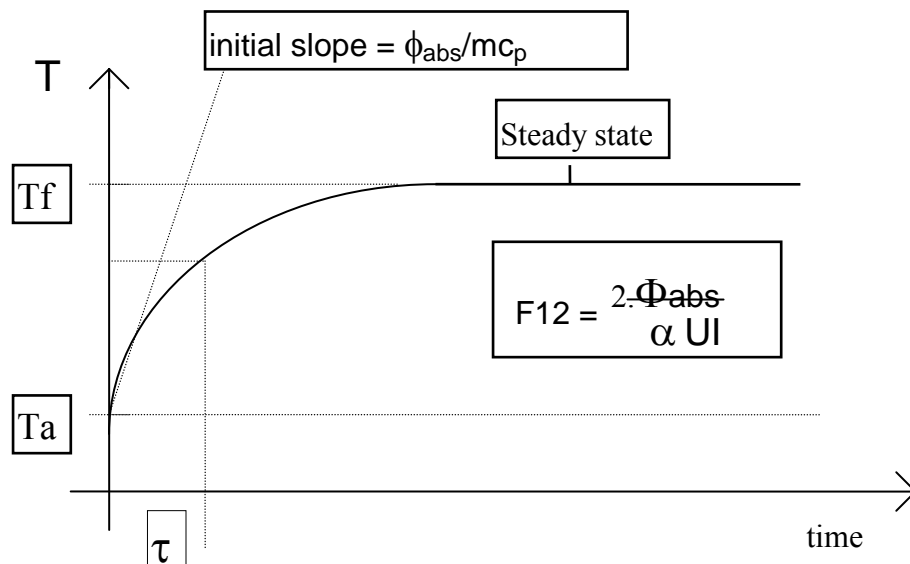
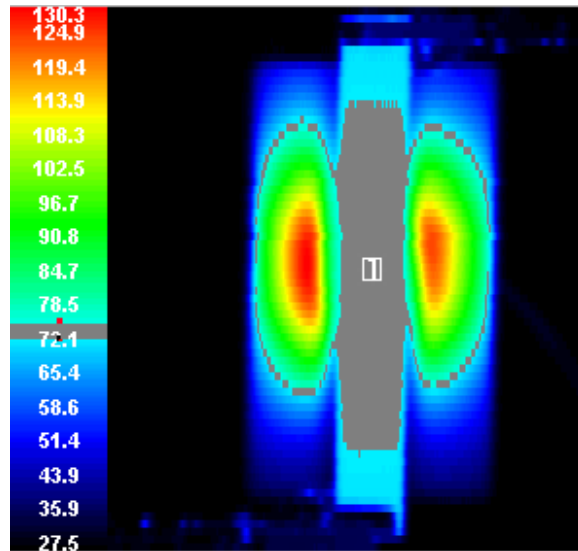

FIGURE 7 : temperature versus time of the sheet

Three configurations were tested (respect to the heater) : centered sheet, shifted sheet, inclined sheet. A thermogram is shown on figure 8 :



selection of the zone  
figure 8

The zone N°1 has been chosen as a reference for the computation of the view factor (this zone is isothermal at 3 %). The results are listed below :

### Results

distance lamp /sheet =10 cm	centered sheet	shifted sheet = 5 cm	inclined sheet 15 °
$T_a$ (°C)	28,9	28,2	29,9
$T_{st}$ (°C)	76,3	68,5	79,2
$\tau$ (seconds)	210	219	217
$h_g$ (W/m <sup>2</sup> K)	16,9	16,1	16,3
$\Phi_{abs}$ (W)	9,32	7,14	9,81
$F_{12}$	0,083	0,063	0,087

the value of the Biot number is #  $8 \cdot 10^{-5}$  and the relative error remains very low (<5 %). The agreement between the simulations and the experimental results is fair :

	centered sheet	shifted sheet	inclined sheet
$F_{12}$ (experimental)	0,083	0,063	0,087
$F_{12}$ (numerical)	0,0866	0,062	0,0913
relative error in %	4,2	1,7	4,7

## Conclusions and prospects

A first approach of the characterization of the interaction between an infrared heating system and a preform has been presented. The spectral and geometrical aspects have been discussed for a further approach; and a simple thermal model to perform a measurement of the view factor in several configurations is presented and easily validated with the infrared thermography technique (Lambertian case). The most particular point of this paper is the using of the Monte Carlo method; the main interest of this « physical computation » (in our context) can be summarized as follows :

- the method work with complex geometry
- a precise description of the radiative transfer in a semi-transparent media such as Polymers (PET/ PVC..) can be done
- The introduction in the model of an anisotropic distribution of intensity is possible (a specific lamp with reflector for example).

Now and for next months : The computation of the view factor in the anisotropic case is being tested and a more accurate experimental setup has been developed to study the heat fluxes on a plastic plate (this plate is instrumented with thermocouples). This device will be used to describe more realistic situations closer to the industrial context.

## References

- [1] **G.Denis**, Extrusion-soufflage et injection-soufflage avec ou sans bi-étirage, Techniques de l'ingénieur, A3700,1989.
- [2] **C.Lindenlaub**, Thermoformage, Techniques de l'ingénieur, A 3660,1982.

[3] **P. Lebaudy**, Etude et simulation de la répartition des températures dans un cylindre creux de PET soumis à un rayonnement infrarouge, thèse de doctorat, 1989.

[4] **Smithells Metals**, Reference handbook - Brandes book, 1990.

[5] **F. Desvignes** , Rayonnements optiques - Masson - 1991.

[6] **Siegel R. and J.R Howell**, Thermal Radiation Heat Transfer, Mc Graw Hill, New York, 1981

[7] **G. Ritoux** , Evaluation numérique des facteurs de formes, Revue de physique appliquée 17, 1982.